



Product Approval Sheet





Customer :

Issued no :2011. 12. 14.

Revision no :

- Product description : Interference Suppression film capacitors
- Product code : PCX2 339●7●●●●●
- Application :

CUSTOMER			
PILKOR	Checked	Confirmed	Approved
			

Headquarters : 381, Woncheon-dong, Yeong tong-gu, Suwon-si, Gyeonggi-do, Korea

PILKOR Electronics Co., Ltd.

TEL. +82-31-217-2500

FAX. +82-31-217-7465

China factory : No 25 Zoutai South Road Rongcheng City, Shandong Province China

Rongcheng PILKOR Electronics Co., Ltd.

TEL. +86-631-755-6001~3

FAX, +86-631-755-6004

* Please send it back to us before placing order.

(Contents)

Safety

- | | | |
|----|---------------------|---------|
| 1. | | Page 1 |
| | (General) | |
| 2. | | Page 7 |
| | (Characteristics) | |
| 3. | | Page 8 |
| | (Mark & Packing) | |
| 4. | | Page 13 |
| | (Test Requirements) | |
| * | (Material) LIST | |

TYPE SPECIFICATION

PILKOR ELECTRONICS CO., LTD.



MKP RADIAL POTTED CAPACITORS

Pitch 10.0/15.0/22.5/27.5/37.5mm

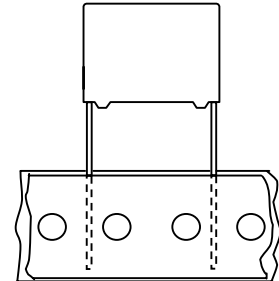
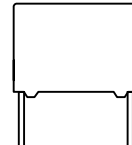
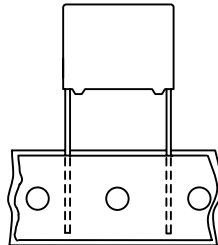
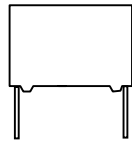

10 and 15mm

22.5 and 27.5mm

QUICK REFERENCE DATA

Capacitance range (E6 series) *	0.001 μ F to 10 μ F
Capacitance tolerance	$\pm 10\%$, $\pm 20\%$
Rated (AC) voltage 50 to 60 Hz	305 V \sim
Climatic category	55/110/21
Temperature range	-55 ~ +110
Reference IEC specification	IEC 60384-14(3rd edition) and EN 60384-14
Safety approvals	UL1414 & CSA-C 22.2 NO. 1 UL1283 & CSA-C 22.2 NO. 8 ENEC, CQC
Potting & Encapsulation material	Qualified in accordance with UL 94V-0
Safety class	X2

* Intermediate values of the E12 series are available to special order

FEATURES	APPLICATIONS
<ul style="list-style-type: none"> . 10.0 to 37.5 mm lead pitch . Supplied loose in box and taped on reel . Consist of a low-inductive wound cell of Metallized Polypropylene film, potted in a flame retardant case 	<ul style="list-style-type: none"> . For X2-electromagnetic interference suppression . Specially designed to meet the NEW REQUIREMENTS in new IEC 60384-14 specification(3rd edition)/EN 60384-14 requiring for X2 a 2.5kV peak pulse voltage test and the UL1414 and CSA-C22.2 No 1 specification

- Please refer to caution and warning at <http://www.pilkor.co.kr/download/Introductions.pdf> before using these products.



Ordering Information

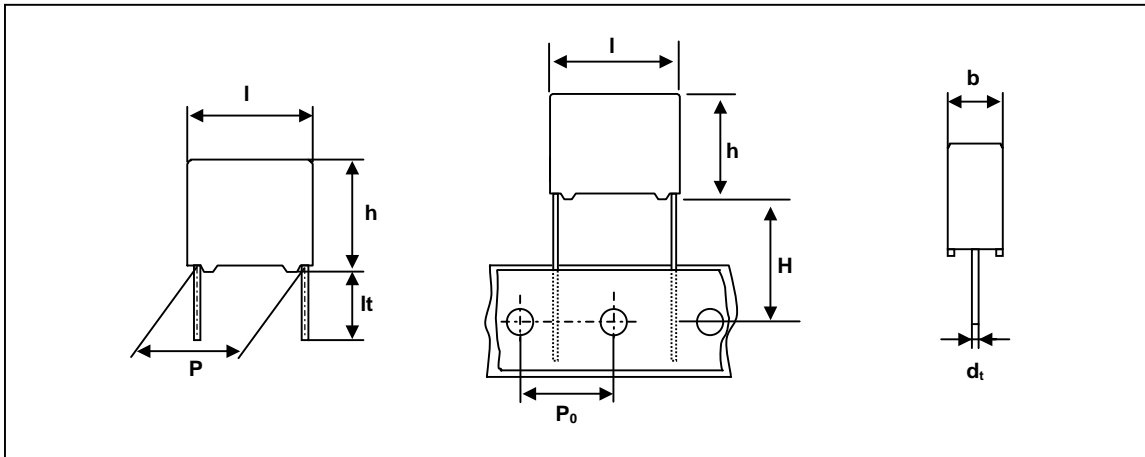

PCX2 339 X X X XXX

Capacitance

Code	Version & Voltage
7	Mini-Cu / 305V
P	Low h-Cu / 305V

Code	Original pitch
D	10.0 mm
F	15.0 mm
J	22.5 mm
L	27.5 mm
Q	37.5 mm

Available versions					Product (I_{max})				
Code	Packing method	C – tol.	Lead length & Height	Hole to hole (P_0)	12.5	18.0	26.0	31.0	42.0
					Pitch (P)				
0	Loose in box	± 20%	lt = 5.0 ± 1.0mm	-	10.0	15.0	22.5	27.5	-
1	Loose in box	± 10%	lt = 5.0 ± 1.0mm	-	10.0	15.0	22.5	27.5	-
4	Loose in box	± 20%	lt = 25.0 ± 2.0mm	-	10.0	15.0	22.5	27.5	37.5
5	Loose in box	± 10%	lt = 25.0 ± 2.0mm	-	10.0	15.0	22.5	27.5	37.5
6	Ammopack	± 20%	H = 18.5mm*	12.7mm	10.0	15.0	22.5	27.5	-
7	Ammopack	± 10%	H = 18.5mm*	12.7mm	10.0	15.0	22.5	27.5	-
Y	Arrange	± 20%	lt = 5.0 ± 1.0mm	-	-	-	-	-	37.5
Z	Arrange	± 10%	lt = 5.0 ± 1.0mm	-	-	-	-	-	37.5

* H ; intape height ; for detailed specifications refer to chapter PACKAGING

** Some values is not following the coding rule.



SAFETY APPROVALS

SAFETY APPROVALS	Voltage	Value	File Number
UL1283 & CSA-C22.2 No. 8 (cUL)	305V(AC)	1nF to 10 μ F	E208404
UL1414 & CSA-C22.2 No. 1 (cUL)	250V(AC)	1nF to 1.0 μ F	E165646
ENEC(SEMKO) *	305V(AC)	1nF to 10 μ F	SE/0256-4
CQC	305V(AC)	1nF to 3.3 μ F	CQC08001023138

* The ENEC-approval together with the CB-Certificate replace all national approval marks of the following countries(they have already signed the ENEC-Agreement): Austria; Belgium; Czech. Republic; Denmark; Finland; France; Germany; Greece; Hungary; Ireland; Italy; Luxembourg; Netherlands; Norway; Portugal; Slovenian; Spain; Sweden; Switzerland and United Kingdom

Packaging Information

SMALLEST PACKING QUANTITIES (SPQ)	LOOSE IN BOX	
	It = 5.0 \pm 1.0 mm	It = 25 \pm 2.0 mm
DIMENSIONS		
4.0 x 10.0 x 12.5	2000	1200
5.0 x 11.0 x 12.5	1500	1000
6.0 x 12.0 x 12.5	1000	1000
5.0 x 11.0 x 18.0	1000	1000
6.0 x 12.0 x 18.0	1000	1000
7.0 x 13.5 x 18.0	1000	1000
8.5 x 13.5 x 18.0	1000	1000
8.5 x 15.0 x 18.0	1000	1000
10.0 x 16.5 x 18.0	1000	1000
11.0 x 18.5 x 18.0	1000	1000
6.0 x 15.5 x 26.0	1000	1000
7.0 x 16.5 x 26.0	1000	1000
8.5 x 18.0 x 26.0	500	500
10.0 x 19.5 x 26.0	500	500
11.5 x 21.0 x 26.0	500	500
13.0 x 23.0 x 26.0	500	500
16.5 x 22.0 x 26.0	250	250
9.0 x 18.0 x 31.0	500	500
11.0 x 21.0 x 31.0	500	250
13.0 x 23.0 x 31.0	250	250
15.0 x 25.0 x 31.0	250	250
18.0 x 28.0 x 31.0	200	200
21.0 x 31.0 x 31.0	150	150
14.0 x 25.0 x 42.0	130*	200
17.0 x 30.0 x 42.0	105*	150
20.0 x 34.0 x 42.0	90*	100
28.0 x 42.5 x 42.0	65*	70

*Arrange packing

Interference Suppression Film capacitors



PCX2 339x7 (Mini)

SPECIFIC REFERENCE DATA FOR 305 V_{AC}

Tangent of loss angle	at 1 khz	at 10 khz
C 470 nF 470 nF < C 1 μF C > 1 μF	10×10^{-4} 20×10^{-4} 30×10^{-4}	20×10^{-4} 70×10^{-4} -
Rated voltage pulse slope (dV/dt) _R P = 10.0mm P = 15.0mm P = 22.5mm P = 27.5mm P = 37.5mm	400 V/μs 300 V/μs 150 V/μs 100 V/μs 100 V/μs	
R between leads, for C 0.33 μF	15 000 MΩ	
RC between leads, for C > 0.33 μF	5 000 s	
Withstanding(DC) Voltage (cut-off current 10mA) C 1 μF C > 1 μF	2250 V 1850 V	

V_{Rac} = 305 V⁻ X2

loose and taped

Cap. (μF)	b x h x l (mm)	MASS (g)	CATALOGUE NUMBER			
			PCX2 339			
			loose in box			
			lt = 5 ± 1.0 mm		lt = 25 ± 2.0 mm	
			C - tol. ±20 %	C - tol. ±10 %	C - tol. ±20 %	C - tol. ±10 %
Pitch = 10.0 ± 0.4 mm			dt = 0.6 +0.06/-0.05 mm			
0.001	4.0 x 10.0x 12.5	0.8	D70102	D71102	D74102	D75102
0.0015	4.0 x 10.0x 12.5	0.8	D70152	D71152	D74152	D75152
0.0022	4.0 x 10.0x 12.5	0.8	D70222	D71222	D74222	D75222
0.0033	4.0 x 10.0x 12.5	0.8	D70332	D71332	D74332	D75332
0.0047	4.0 x 10.0x 12.5	0.8	D70472	D71472	D74472	D75472
0.0068	4.0 x 10.0x 12.5	0.8	D70682	D71682	D74682	D75682
0.01	4.0 x 10.0x 12.5	0.8	D70103	D71103	D74103	D75103
0.015	4.0 x 10.0x 12.5	0.8	D70153	D71153	D74153	D75153
0.022	4.0 x 10.0x 12.5	0.8	D70223	D71223	D74223	D75223
0.033	5.0 x 11.0 x 12.5	0.9	D70333	D71333	D74333	D75333
0.047	5.0 x 11.0 x 12.5	0.9	D70473	D71473	D74473	D75473
0.068	6.0 x 12.0 x 12.5	1.0	D70683	D71683	D74683	D75683
0.1	6.0 x 12.0 x 12.5	1.0	D70104	D71104	D74104	D75104

 $V_{Rac} = 305 V^{-} X2$

loose and taped

Cap. (μF)	b x h x l (mm)	MASS (g)	CATALOGUE NUMBER			
			PCX2 339			
			loose in box			
			lt = 5 \pm 1.0 mm		lt = 25 \pm 2.0 mm	
			C - tol. $\pm 20\%$	C - tol. $\pm 10\%$	C - tol. $\pm 20\%$	C - tol. $\pm 10\%$
Pitch = 15.0 \pm 0.4 mm			dt = 0.8 +0.08/-0.05 mm			
0.01	5.0 x 11.0 x 18.0	1.6	F70103	F71103	F74103	F75103
0.015	5.0 x 11.0 x 18.0	1.6	F70153	F71153	F74153	F75153
0.022	5.0 x 11.0 x 18.0	1.6	F70223	F71223	F74223	F75223
0.033	5.0 x 11.0 x 18.0	1.6	F70333	F71333	F74333	F75333
0.047	5.0 x 11.0 x 18.0	1.6	F70473	F71473	F74473	F75473
0.068	5.0 x 11.0 x 18.0	1.6	F70683	F71683	F74683	F75683
0.1	5.0 x 11.0 x 18.0	1.6	F70104	F71104	F74104	F75104
0.15	6.0 x 12.0 x 18.0	1.7	F70154	F71154	F74154	F75154
0.22	7.0 x 13.5 x 18.0	1.9	F70224	F71224	F74224	F75224
0.33	8.5 x 13.5 x 18.0	2.4	FP0334	FP1334	FP4334	FP5334
0.33	8.5 x 15.0 x 18.0	2.6	F70334	F71334	F74334	F75334
0.47	10.0 x 16.5 x 18.0	3.1	F70474	F71474	F74474	F75474
0.68	11.0 x 18.5 x 18.0	4.1	F70684	F71684	F74684	F75684
Pitch = 22.5 \pm 0.4 mm			dt = 0.8 +0.08/-0.05 mm			
0.22	6.0 x 15.5 x 26.0	3.0	J70224	J71224	J74224	J75224
0.33	6.0 x 15.5 x 26.0	3.0	J70334	J71334	J74334	J75334
0.47	7.0 x 16.5 x 26.0	3.5	J70474	J71474	J74474	J75474
0.68	8.5 x 18.0 x 26.0	4.4	J70684	J71684	J74684	J75684
1.0	10.0 x 19.5 x 26.0	5.5	J70105	-	J74105	-
1.0	11.5 x 21.0 x 26.0	6.5	-	J71105	-	J75105
1.5	13.0 x 23.0 x 26.0	8.0	J70155	J71155	J74155	J75155
2.2	16.5 x 22.0 x 26.0	10.0	JP0225	JP1225	JP4225	JP5225
Pitch = 27.5 \pm 0.4 mm			dt = 0.8 +0.08/-0.05 mm			
0.68	9.0 x 19.0 x 31.0	5.5	L70684	L71684	L74684	L75684
1.0	11.0 x 21.0 x 31.0	7.8	L70105	L71105	L74105	L75105
1.5	13.0 x 23.0 x 31.0	10.4	L70155	L71155	L74155	L75155
2.2	15.0 x 25.0 x 31.0	12.8	L70225	L71225	L74225	L75225
3.3	18.0 x 28.0 x 31.0	17.2	L70335	L71335	L74335	L75335
4.7	21.0 x 31.0 x 31.0	20.4	L70475	L71475	L74475	L75475
Pitch = 37.5 \pm 0.7 mm			dt = 1.0 +0.1/-0.1 mm			
2.2	14.0 x 25.0 x 42.0	15.0	Q7Y225*	Q7Z225*	Q74225	Q75225
3.3	14.0 x 25.0 x 42.0	15.0	Q7Y335*	Q7Z335*	Q74335	Q75335
4.7	17.0 x 30.0 x 42.0	25.3	Q7Y475*	Q7Z475*	Q74475	Q75475
6.8	20.0 x 34.0 x 42.0	33.6	Q7Y685*	Q7Z685*	Q74685	Q75685
10	28.0 x 42.5 x 42.0	51.9	Q7Y106*	Q7Z106*	Q74106	Q75106

* Arrange packing

MOUNTING
NORMAL USE

The capacitors are designed for mounting on printed-circuit boards.

The capacitors packed in bandoliers are designed for mounting on printed-circuit boards by means of automatic insertion machines.

For detailed specifications refer to chapter "PACKAGING".

SPECIFIC METHOD OF MOUNTING TO WITHSTAND VIBRATION AND SHOCK

In order to withstand vibration and shock tests, it must be ensured that the stand-off pins are in good contact with the printed-circuit board.

. For pitches of 15mm the capacitors shall be mechanically fixed by leads.

. For larger pitches the capacitors shall be mounted in the same way and the body clamped.

SPACE REQUIREMENTS ON PRINTED-CIRCUIT BOARD

The maximum length and width of film capacitors are shown in the following drawing ;

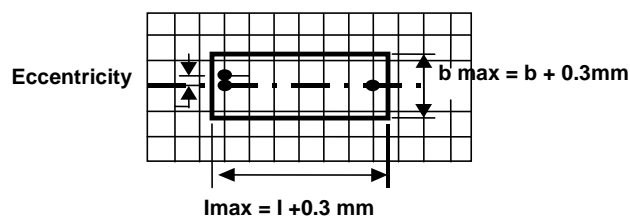

- Eccentricity as in drawing.

The maximum eccentricity is smaller than or equal to the lead diameter of the product concerned.

- Product height with seating plane as given by IEC 60717 as reference : $h_{\max} \quad h+0.3\text{mm}$



RATINGS AND CHARACTERISTICS

Unless otherwise specified all electrical values apply to an ambient temperature of 23 ± 1 °C, an atmospheric pressure of 86 to 106kPa and a relative humidity $50 \pm 2\%$.

For reference testing, a conditioning period shall be applied of 96 ± 4 hours by heating the products in a circulating air oven at the rated temperature and a relative humidity not exceeding 20%.

Maximum RMS Voltage as a function of frequency

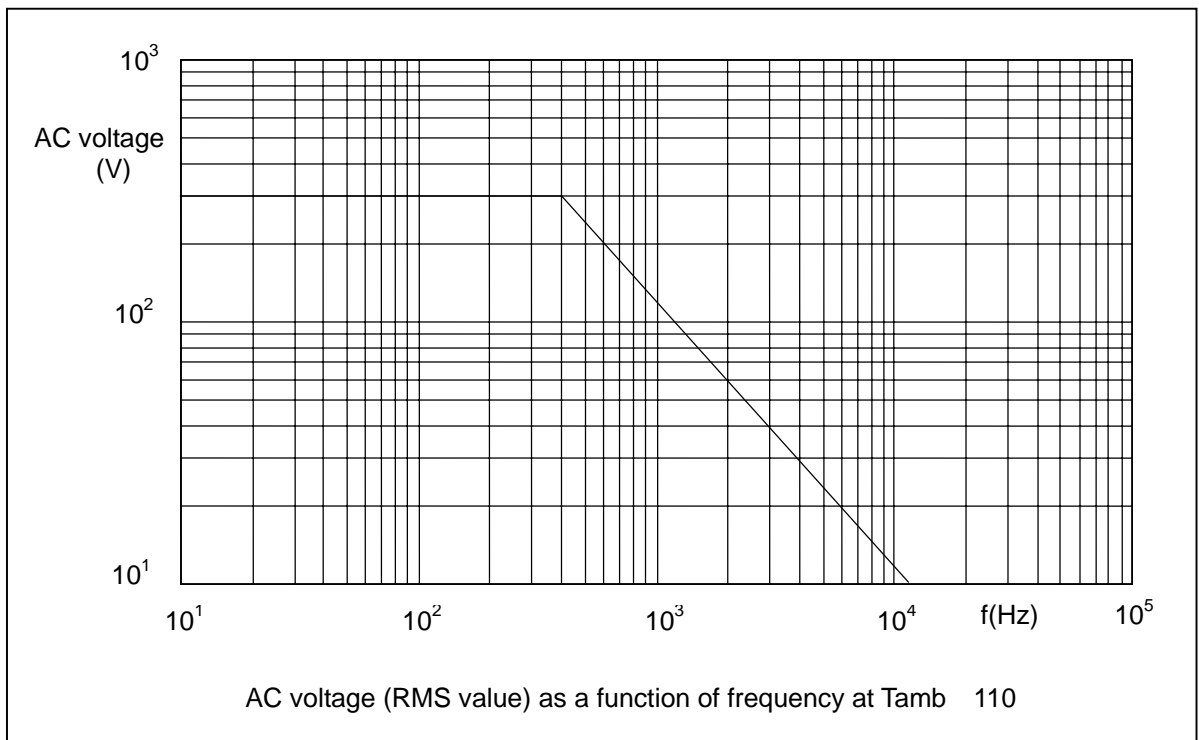



PRODUCT MARKING

Capacitors are marked with having following information;

- 1.Manufacturer (PILKOR)
- 2.Manufacturer's type designation (PCX2 339)
- 3.Rated capacitance in code according to IEC 60062
- 4.Rated (AC) voltage (305V~)
- 5.Sub class (X2)
- 6.Tolerance on rated capacitance M =±20 % K = ±10 %
- 7.Climatic category (55/110/21)
- 8.Code for dielectric material (MKP)
- 9.Year and week of manufacturing (e.g. 0901)
- 10.Safety approvals

Example of marking

Pitch P = 7.5mm or 10mm or 15mm



Marking on the side

Pitch P = 15.0mm or P = 22.5 mm or P = 27.5mm
(C 1uF)

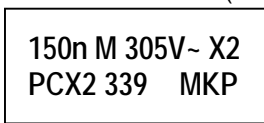

Marking on the top



Marking on the side

or

(C>1uF)

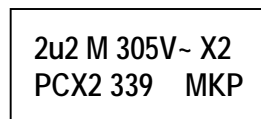

Marking on the top



Marking on the side

Pitch P = 22.5 mm or P = 27.5mm or P = 37.5mm



Marking on headface(C 1uF)

or

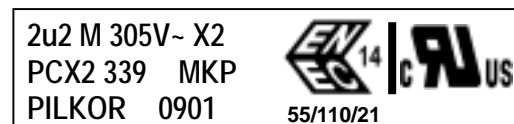

Marking on headface(C > 1uF)



PACKAGE MARKING

The package containing the capacitors in marking as shown.

For C 1uF

For 1uF < C 3.3uF

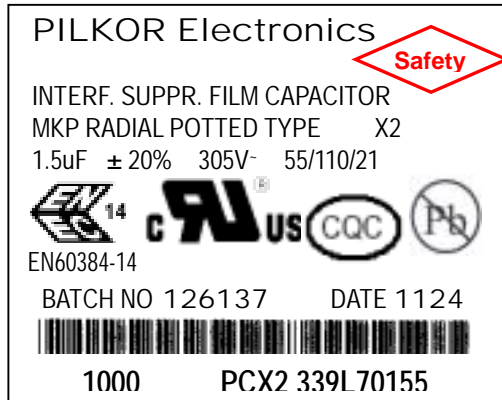
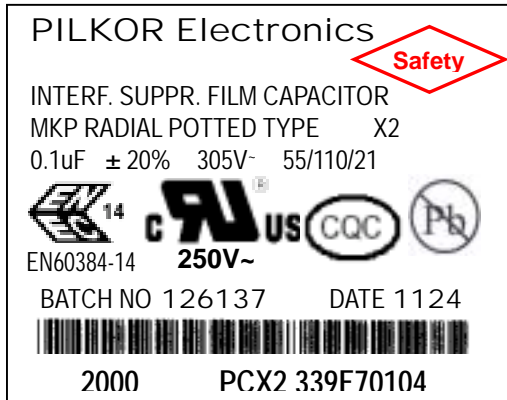

For 3.3uF < C 10uF

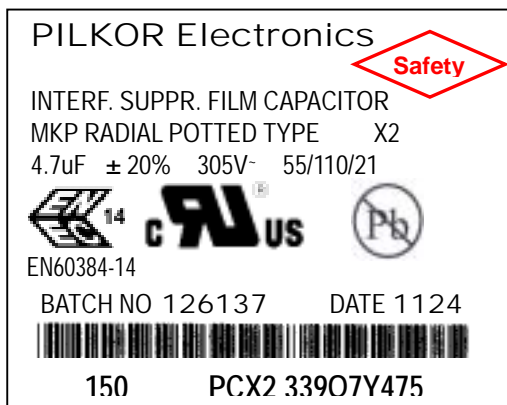

- 1 Manufacturer's name
- 2 Sub-family
- 3 Type description, safety class X2, Series name
- 4 Capacitance value, tolerance, voltage and climatic category (IEC)
- 5 Safety approvals
- 6 Batch nr. & production period year and week code
- 7 Quantity and Product code (12NC)

*** Color of label : Pink

Color of Marking : Red



PACKAGING

**DIMENSIONS OF TAPED PRODCUTS
TAPED ON REEL**

Capacitor with terminal pitch P = 10 mm

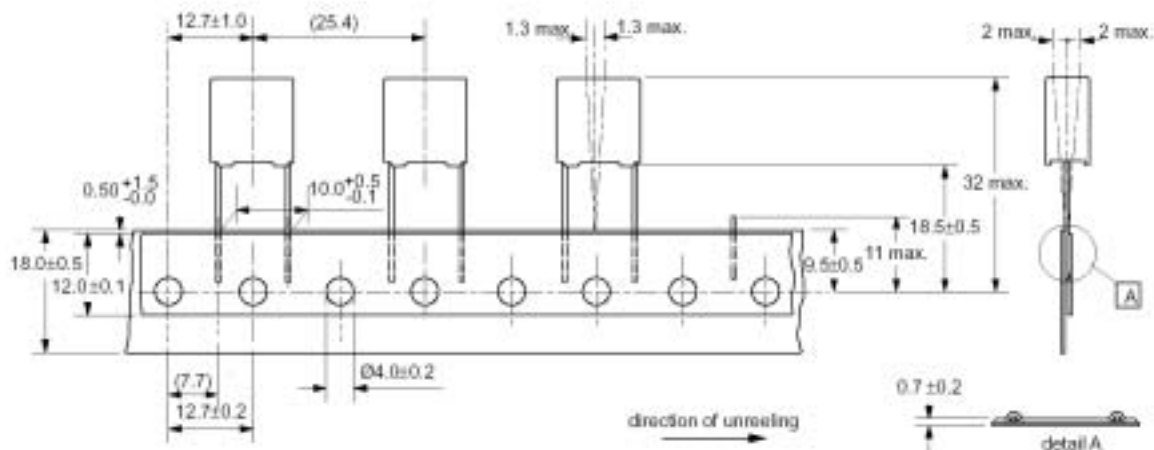

Capacitor with terminal pitch P = 15 mm.

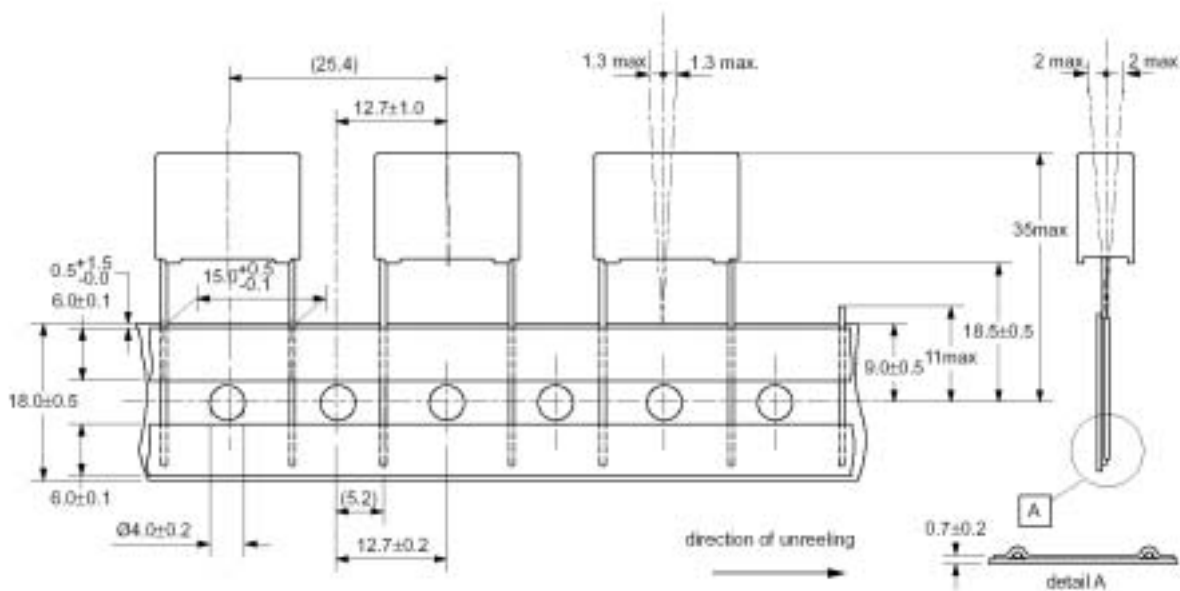



Capacitor with terminal pitch P = 22.5 or 27.5 mm

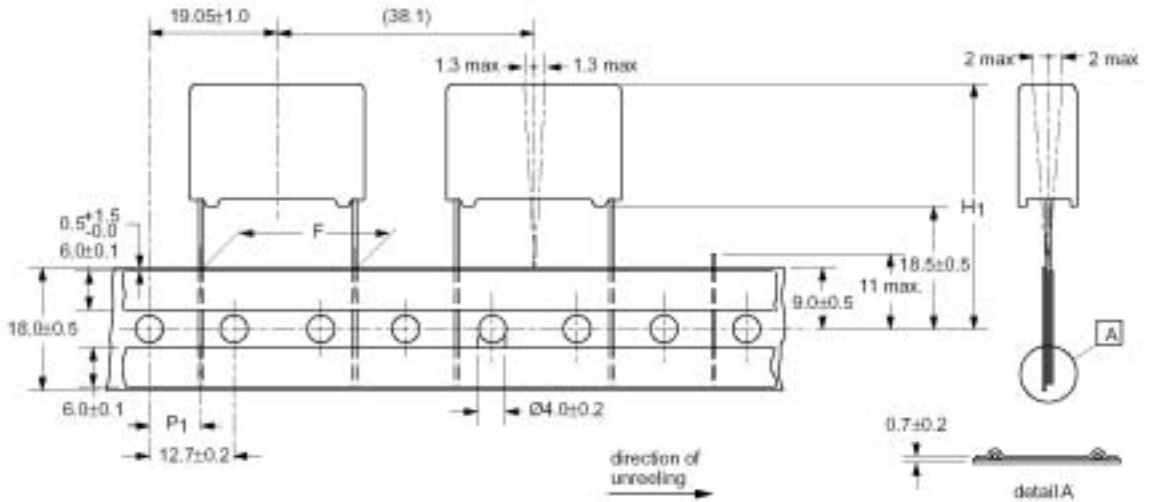

ITEM	SYMBOL	VALUE	VALUE	TOLERANCE
LEAD TO LEAD DISTANCE(mm)	F	22.5	27.5	+0.5/-0.1
HEIGHT OF COMPONENT FROM TAPE CENTER TO SEATING PLANE(mm)	H	18.5		0.5
COMPONENT HEIGHT FROM TAPE CENTER(mm)	H ₁	40 max	48 max	
FEED HOLE TO LEAD CENTER(mm)	P ₁	7.8	5.33	0.7



CHARACTERISTICS OF TAPED PRODUCTS

Cumulative pitch error 1.0mm/20 pitches

Pull-out force of the component **5 N**

Pull-out force of the adhesive tape **6 N**

Tearing force of tape **15 N**

Storage temperature **- 25 to + 40**

Relative humidity **max. 80% without condensation**

The max. number of empty places per reel shall not exceed 0.5% of the total number of components per reel, but no more than 2 consecutive positions may be vacant.

Outlines of reel & ammo packing (dimensions in mm)

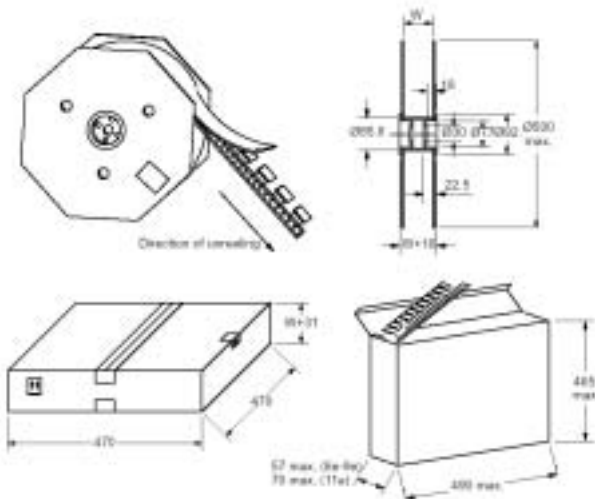

W as function of product dimensions

l = 12.5 or 18.0 mm		l = 26 or 31 mm	
b (mm)	W 2 (mm)	b (mm)	W 2 (mm)
4.0	40	6.0	50
5.0	45	7.0	50
6.0	45	8.5	50
7.0	45	9.0	50
8.5	45	10.0	50
10.0	50	11.0	55
		13.0	55
		15.0	60
		18.0	60



INSPECTION REQUIREMENTS

Note 1 : Sub-clause numbers of tests and performance requirements refer to the Sectional Specification, IEC 384-14 and Section One this specification.

Note 2 : Inspection levels are selected from IEC-Publication 410: Sampling Plans and Procedures for inspection by attributes.

Note 3 : In this table : p = periodicity in months
n = sample size
D = destructive
ND = non-destructive
IL = inspection level) IEC 410
AQL = acceptance quality level)

Note 4 : For this capacitors, considered as a solid construction, the periodicity of the vibration and shock test is reduced from 36 months to 6 months.

Clause number and Test	D or ND	Condition	IL	n	Performance Requirements
Group A inspection (lot by lot)					
Sub-Group A1	ND				
4.1 Visual examination		Detail	S4	1)	No visual damage , legible marking and as specified in Marking specification
4.1 Dimensions 2)			S3	1)	As specified in dimension table of this specification
Sub-Group A2 3)	ND				
4.2.2 capacitance		At 1kHz (max 5Vrms)			Within specified tolerance
4.2.3 Tangent of loss angle		At 10kHz C = 1 μ F At 1kHz C > 1 μ F			As in rating and characteristics of this specification
4.2.4 Voltage proof (test A)		1. C = 1 μ F 2250V 1min 2. C > 1 μ F 1350V 1min			No permanent breakdown (cut-off current 10mA) or flash over Self-healing allowed
4.2.5 Insulation resistance (test A)		At 100V 1min.			As in rating and characteristics of this specification

1) Number to be tested : Sample size as directly allotted to the code letter for IL in Table 2A of IEC 410 (Single sampling plan for normal inspection)
The acceptance number complies with AQL value : 0.65 %

2) This test may be replaced by in-production testing, if SPC on dimensional measurements or other mechanisms to avoid parts exceeding the limits is installed.

3) The 100% End-of-line testing is followed by re-inspection by sampling in order to monitor outgoing quality level by defectives per million (DPM). The sampling level and the calculation of DPM values is in accordance with CECC 00 014, counting any parametric failure as a defective. In case one or more defectives occur in a lot, this lot shall be rejected.



Clause number and Test	D or ND	Condition	p	n	Performance Requirements
Group C inspection (periodic)			6	6	
Sub-group C1A Part of a sample of sub-group C1	D				
4.1 dimension (detail)					As specified in dimension table of this specification
4.3.1 initial measurement		1. Capacitance at 1kHz 2. Tangent of loss angle at 10kHz C $1\mu\text{F}$ at 1kHz C $> 1\mu\text{F}$			
4.3 robustness of terminations		Tensile and bending			No visible damage
4.4 resistance to soldering heat		Method : 1A Solder bath : 260 Duration : 10 s			
4.14 component solvent resistance		Isopropylalcohol at room temperature Method : 2 Immersion time : $5\pm 0.5\text{min}$ Recovery time: min 1hour max 2hours			
4.4.2 final measurements		Visual examination 1. Capacitance at 1kHz 2. Tangent of loss angle at 10kHz C $1\mu\text{F}$ at 1kHz C $> 1\mu\text{F}$			No visible damage Legible marking C/C 5% of the value measured initially Increase of tanD For C $1\mu\text{F}$ < 0.0080 For C $> 1\mu\text{F}$ < 0.0050
		Insulation resistance			As in rating and characteristics of this specification



Clause number and Test	D or ND	Condition	p	n	Performance Requirements
Group C inspection (periodic)					
Sub-group C1B Other part of a sample of sub-group C1	D		6	12	
4.6.1 initial measurement		1. Capacitance at 1kHz 2. Tangent of loss angle at 10kHz C $1\mu\text{F}$ at 1kHz C $> 1\mu\text{F}$			
4.6 rapid change of temperature		A = lower category temperature B = upper category temperature 5 cycles duration time : 30 min			
4.7 vibration (see note 4)		Method of mounting : see the mounting of this specification Procedure : B4 Frequency range 10Hz to 55Hz amplitude : 0.75mm or acceleration 98m/s ² (which is less severe) Total duration : 6 hours			
4.7.2 final examination		Visual examination			No visible damage
4.9 shock (see note 4)		Method of mounting : see the mounting of this specification Pulse shape : half sine Acceleration : 490 m/s ² Duration of pulse : 11ms			
4.9.3 final measurements		Visual examination 1. Capacitance at 1kHz 2. Tangent of loss angle at 10kHz C $1\mu\text{F}$ at 1kHz C $> 1\mu\text{F}$ Insulation resistance			No visible damage C/C 5% of the value measured initially Increase of tanD For C $1\mu\text{F}$ < 0.0080 For C $> 1\mu\text{F}$ < 0.0050 As in rating and characteristics of this specification



Clause number and Test	D or ND	Condition	p	n	Performance Requirements
Group C inspection (periodic)					
Sub-group C1 Combined sample of specimens of sub-groups C1A and C1B	D		6	18	
4.11 climatic sequence 4.11.2 dry heat 4.11.3 damp heat cyclic test Db, first cycle 4.11.4 cold 4.11.6 damp heat cyclic test Db, remaining cycle 4.11.6.2 final measurements		<p>$T = T_{\text{upper-category temperature}}$ Duration : 16 hours</p> <p>$T = T_{\text{lower-category temperature}}$ Duration : 2 hours</p> <p>Visual examination</p> <p>1. Capacitance at 1kHz</p> <p>2. Tangent of loss angle at 10kHz $C \leq 1\mu\text{F}$ at 1kHz $C > 1\mu\text{F}$</p> <p>Insulation resistance</p> <p>Voltage proof 1350V (DC) for 1min</p>			<p>No visible damage Legible marking</p> <p>C/C 5% of the value measured initially</p> <p>Increase of tanD For $C \leq 1\mu\text{F}$ < 0.0080 For $C > 1\mu\text{F}$ < 0.0050 50% of values in ratings and characteristics of this specification</p> <p>No permanent breakdown or flash over</p>



Clause number and Test	D or ND	Condition	p	n	Performance Requirements
Sub-group C2	D		6	10	
4.12 damp heat steady state 4.12.1 initial measurements 4.12.3 final measurements		21 days, 40 90 – 95% R.H 1. Capacitance at 1kHz 2. Tangent of loss angle at 10kHz C $\leq 1\mu\text{F}$ at 1kHz C $> 1\mu\text{F}$ Visual examination 1. Capacitance at 1kHz 2. Tangent of loss angle at 10kHz C $\leq 1\mu\text{F}$ at 1kHz C $> 1\mu\text{F}$ Voltage proof 1350V (d.c) 1min Insulation resistance			No visible damage Legible marking C/C 5% of the value measured initially Increase of tanD For C $\leq 1\mu\text{F}$ < 0.0080 For C $> 1\mu\text{F}$ < 0.0050 No permanent breakdown or flash over 50% of values in ratings and characteristics of this specification



Clause number and Test	D or ND	Condition	p	n	Performance Requirements
Sub-group C3	D		3	12	
4.13.1 initial measurements		1. Capacitance at 1kHz 2. Tangent of loss angle at 10kHz C \leq 1 μ F at 1kHz C $>$ 1 μ F			No selfhealing breakdown or flashover
4.13 peak impulse voltage		3 successive impulse, full wave, peak voltage : for C \leq 1 μ F : 2.5kV for C $>$ 1 μ F : 2.5kV/ C (C in μ F) max : 24 pulses			
4.14 endurance test		Duration : 1000 hours 1.25 x V _{Rac} at 110 once in every hour the voltage is increased to 1000V(RMS) for 0.1 s via a resistor of 47 \pm 5%			
4.12.3 final measurements		Visual examination			
		1. Capacitance at 1kHz 2. Tangent of loss angle at 10kHz C \leq 1 μ F at 1kHz C $>$ 1 μ F Insulation resistance Voltage proof 1350V (DC) for 1 min			
					No visible damage Legible marking C/C 10% of the value measured initially Increase of tanD For C \leq 1 μ F < 0.0080 For C $>$ 1 μ F < 0.0050 50% of values in ratings and characteristics of this specification No permanent breakdown or flashover



Clause number and Test	D or ND	Condition	p	n	Performance Requirements
Sub-group C4	D		6	6	
4.15.1 initial measurements 4.15 charge and discharge 4.15.3 final measurements		<p>1. Capacitance at 1kHz 2. Tangent of loss angle at 10kHz C \leq 1μF at 1kHz C > 1μF</p> <p>10000 cycles : charge to V_R half sine wave Duration : 5ms Discharge resistance</p> $R = \frac{V_{RAC} \times 2}{1.5 \times C \times (dU/dt)}$ <p>with a minimum : 2.2</p> <p>1. Capacitance at 1kHz 2. Tangent of loss angle at 10kHz C \leq 1μF at 1kHz C > 1μF</p> <p>Insulation resistance</p>			<p>C/C 10% of the value measured initially</p> <p>Increase of tanD For C \leq 1μF < 0.0080 For C > 1μF < 0.0050 50% of values in ratings and characteristics of this specification</p>



Clause number and Test	D or ND	Condition	p	n	Performance Requirements										
Sub-group C6	D		12	18											
4.17 passive flammability		<p>Bore of gas jet : 0.5 mm Fuel : Butane Test duration for actual volume V in mm³</p> <p>class C</p> <table border="1"> <thead> <tr> <th>Volume(mm³)</th> <th>Gas jet</th> </tr> </thead> <tbody> <tr> <td>V 250</td> <td>5s</td> </tr> <tr> <td>250 V 500</td> <td>10s</td> </tr> <tr> <td>500 V 1750</td> <td>20s</td> </tr> <tr> <td>V > 1750</td> <td>30s</td> </tr> </tbody> </table> <p>One flame application</p>	Volume(mm ³)	Gas jet	V 250	5s	250 V 500	10s	500 V 1750	20s	V > 1750	30s			<p>1.class C After removing test flame from capacitor, the capacitor must not continue burn for more than 30 s.</p> <p>2.No burning particle must drop from the sample</p>
Volume(mm ³)	Gas jet														
V 250	5s														
250 V 500	10s														
500 V 1750	20s														
V > 1750	30s														
Sub-group C7	D		12	24											
4.18 active flammability		<p>20 discharges of a 3 uF tankcapacitor across the test capacitor. The test capacitor during the discharges connected to V_R (16A). V_R is maintained for 2 min after the last discharge</p>			<p>The cheese cloth around the capacitor shall not burn with a flame. Not electrical measurements are required.</p>										



Clause number and Test	D or ND	Condition	p	n	Performance Requirements
Sub-group ADD1	D		3	10	
A.1 Solder ability Solvent resistance of the marking		Without aging Method : 1 Non-activated colophiny flux 501 Solder bath : 245 Dwell time : 3s Isopropylalcohol at room temperature. Method : 1 Rubbing material cotton wool Immersion time : 5±0.5min			Good tinning as evidenced by free flowing of the solder with wetting of the termination(> 95%) Legible marking
Sub-group ADD2	D		3	12	
A.2 Heat storage A.2.1 Initial measurement A.2.2 Final measurement		Duration : 1000h Temperature : upper category temperature 1. Capacitance at 1kHz 2. Tangent of loss angle at 10kHz C ≤ 1μF at 1kHz C > 1μF 1. Capacitance at 1kHz 2. Tangent of loss angle at 10kHz C ≤ 1μF at 1kHz C > 1μF Insulation resistance			C/C 5% of the value measured initially Increase of tanD For C ≤ 1μF < 0.0080 For C > 1μF < 0.0050 As in Rating and CHARACTERISTICS of this specification



Clause number and Test	D or ND	Condition	p	n	Performance Requirements
Sub-group ADD3	D		3	9	
A.3 Detergent resistance A.3.1 Initial measurement A.3.2 Final measurement		Density 20g/L dishwasher detergent Temperature 70 during 3 minutes followed by rinsing in clear water for 1 minute Recovery time : 1 to 2 hours 1. Capacitance at 1kHz 2. Tangent of loss angle at 10kHz C $1\mu\text{F}$ at 1kHz C $> 1\mu\text{F}$ 1. Capacitance at 1kHz 2. Tangent of loss angle at 10kHz C $1\mu\text{F}$ at 1kHz C $> 1\mu\text{F}$ Insulation resistance			Good tinning as evidenced by free flowing of the solder with wetting of the termination(> 95%) C/C 5% of the value measured initially Increase of tanD For C $1\mu\text{F}$ < 0.0080 For C $> 1\mu\text{F}$ < 0.0050 50% of values in ratings and characteristics of this specification
Sub-group ADD4	D		6	10	
A.4 Resistance to soldering heat with preheating A.2.1 Initial measurement A.2.2 Final measurement		Capacitors mounted on 1.6mm board with nonplated hole Body temp : 100 Bath temp : > 260 Dwell time : 10 s 1. Capacitance at 1kHz 2. Tangent of loss angle at 10kHz C $1\mu\text{F}$ at 1kHz C $> 1\mu\text{F}$ 1. Capacitance at 1kHz			C/C 5% of the value measured initially Increase of tanD For C $1\mu\text{F}$ < 0.0080 For C $> 1\mu\text{F}$ < 0.0050
Sub-group ADD5	D		12	10	
A.5 Thermal Shock		θA = lower category temperature θB = upper category temperature 100 cycles Duration t = 30 min			$\Delta\text{C/C} \leq 10\%$ $\Delta\text{tan}\delta(1\text{KHz}) < 0.005$ $\text{R}_{\text{ins}} \geq 50\%$ specified value

MATERIAL LIST

- Product type ; Metallized Polypropylene film capacitors
- Model name ; PCX2 Series

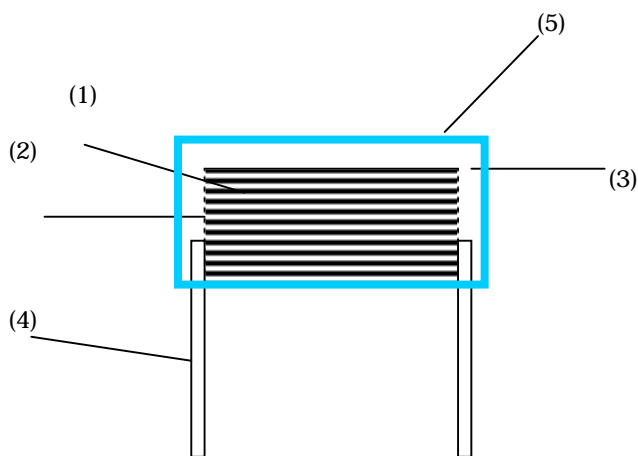

Metallized Polypropylene film



	Description	Material	Supplier
1	MKP Film	Metallized polypropylene	SUNGMOON Elec.(Korea) NUINTEK(Korea)
2	Metal Spray	Tin-Zinc	SAMHWA Non-Ferrous metal Ind. SHINSAENG metal Ind.
3	Epoxy	UL94V-0	DAEJOO Fine chemical GREEN STAR
4	Lead wire	Tin plated Copper wire 0.6/0.8mm [Sn100%: 10 μm]	ILKWANG DAE-A LEAD SAMATRON
5	PP case	POLYPROPYLENE UL94-V0	SAMSUNG Total LG Chemical