

SPECIFICATION FOR APPROVAL

CUSTOMER	_____
CUST. PART NO.	_____
CUST. DOC. REV.	_____
DESCRIPTION	MOLDED POWER CHOKE (RoHS+H.F.)
SAMPLE LOT NO.	_____
PART NO.	MCS20FC-XXXMMP
DOC. REV.	ORIG
DATE	_____

Once you approve this part, please sign and return this page to the following marked location.

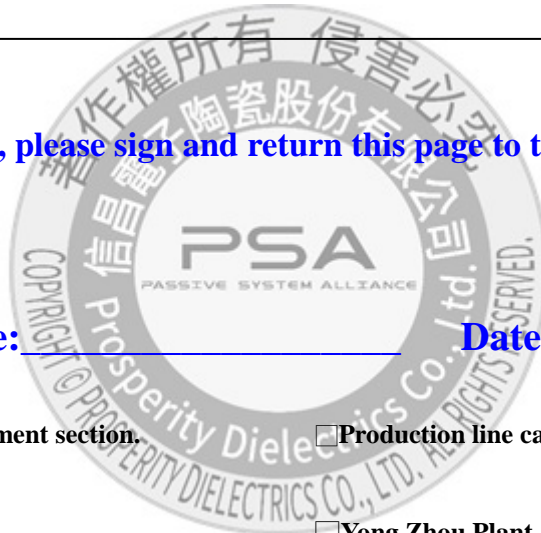

Customer Signature: _____ Date: _____

This part currently development section. Production line can produce this series of products.

Sales Office-Headquarter

No. 566-1, Kao-Shi Rd., Yangmei, Taoyuan 32668,
Taiwan
TEL: +886-3-475-3355
FAX: +886-3-485-4959

Yong Zhou Plant

Tao-Yuan Rd., Fenghuang Park, Lengshuitan
District, Yongzhou, Hunan 425000, P.R.C.
TEL: +86-746-8610-180
FAX: +86-746-8610-181

Sales Office-Dong Guan,China

No.638,Mei Jing West Road Xiniupo Administrative
Zone Dalang Town,Dong Guan City,GuangDong
Province,China.
TEL: +86-769-8555-0979
FAX: +86-769-8555-0972

TESTED BY	CHECKED BY	APPROVED BY

TABLE OF CONTENTS

INDEX	Page
■ Engineering Change Notice - Record	2
■ Part Number Identification	3
■ Mechanical Dimension	3
■ Electrical Specification	3
■ Electrical Curve	4
■ Reliability Performance	5
■ Reflow Chart	6
■ Packing	7
■ Test Report	

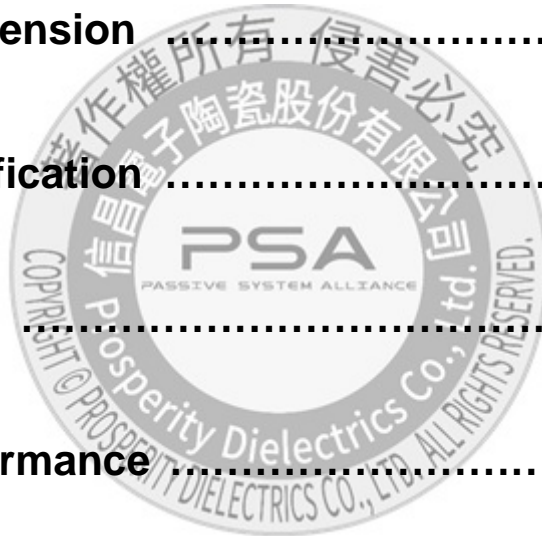

SPECIFICATION FOR APPROVAL

CUSTOMER	CUSTOMER P/N	REV. —	SPL. LOT NO.	
PART NAME MOLDED POWER CHOKE(RoHS+H.F.)	PART NO. MCS20FC-XXXMMP	REV. ORIG	DATE OF ISSUE	Q'TY 0 PCS

ENGINEERING CHANGE NOTICE - RECORD

REVISION NO.	REVISION DESCRIPTION	AUTHOR	DATE	REMARK
ORIG		Gary Chang		



SPECIFICATION FOR APPROVAL

- ✘ This is a RoHS and REACH compliant product whose related documents are available on request.
- ✘ Graphic is only for dimensionally application.

1. PART NUMBERING IDENTIFICATION

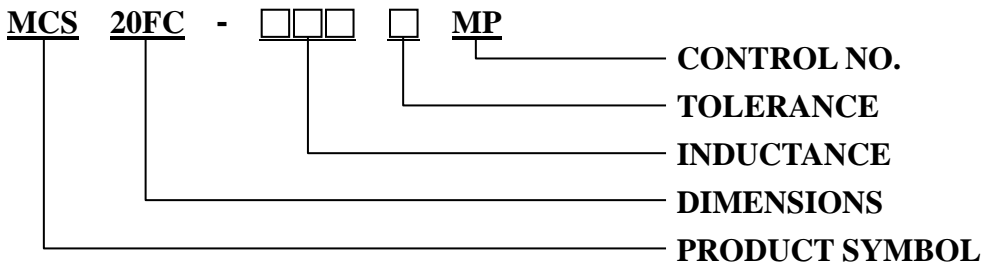

2. MECHANICAL DIMENSION

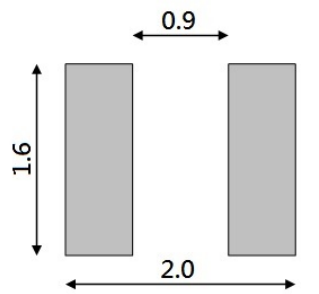
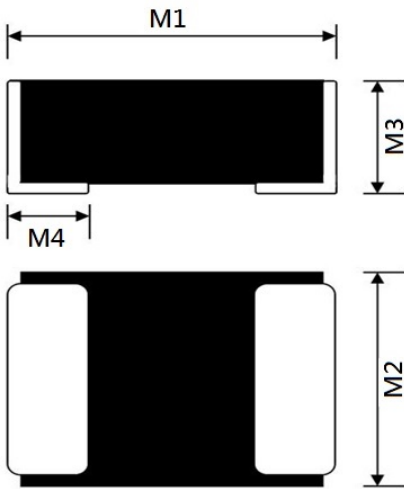

UNIT: mm

	DIM.	TOL.
M1	2.0	±0.2
M2	1.6	±0.2
M3	1.0	MAX.
M4	0.5	±0.3

3. ELECTRICAL SPECIFICATION

Part number	Inductance (uH)	DC Resistance (mΩ)	DC Resistance (mΩ)	Irms (A)	Irms (A)	I sat (A)	I sat (A)
	±20%	Typical	MAX.	Typical	MAX.	Typical	MAX.
MCS20FC-R24MMP	0.24	17	21	5.0	4.50	5.6	5.05
MCS20FC-R33MMP	0.33	24	29	4.1	3.69	5.0	4.50
MCS20FC-R47MMP	0.47	33	40	3.5	3.15	4.4	4.00
MCS20FC-R68MMP	0.68	41	49	3.4	3.06	3.7	3.33
MCS20FC-1R0MMP	1.0	60	69	2.6	2.26	2.9	2.61
MCS20FC-1R5MMP	1.5	114	129	2.0	1.81	2.5	2.25
MCS20FC-2R2MMP	2.2	135	150	1.7	1.50	1.9	1.71

NOTE:

1. Test Freq.: 1MHz, 1V
2. All test referenced to 26°C ambient.
3. Operating Temperature range: -40°C to +125°C
4. Storage Temperature range: -50°C to +125°C
5. Isat means that DC current will cause a 30% inductance reduction from initial value.
6. Irms means that DC current will cause coil temp. rising to 40°C whichever is smaller.

SPECIFICATION FOR APPROVAL

4. ELECTRICAL CURVE

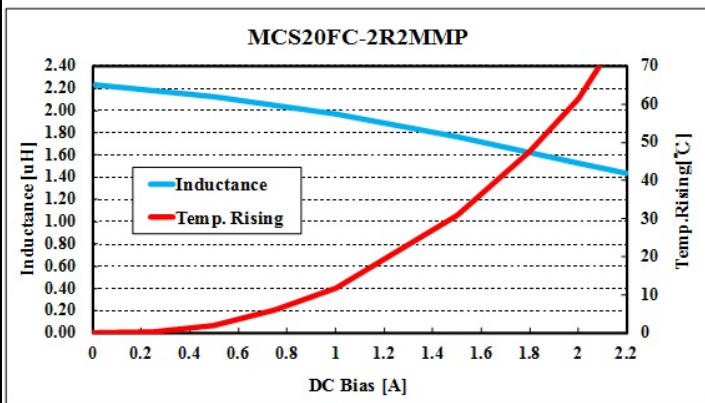
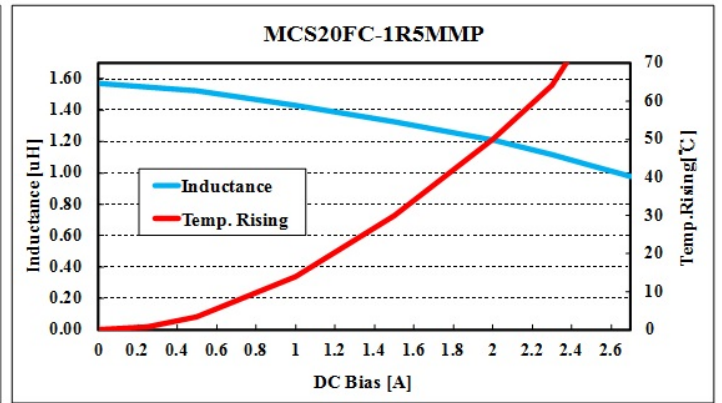
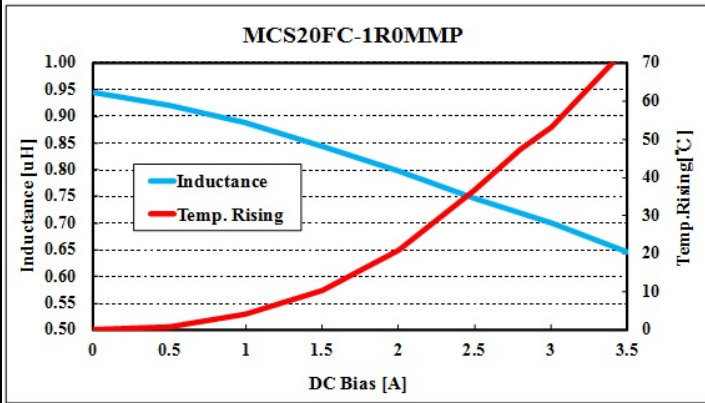
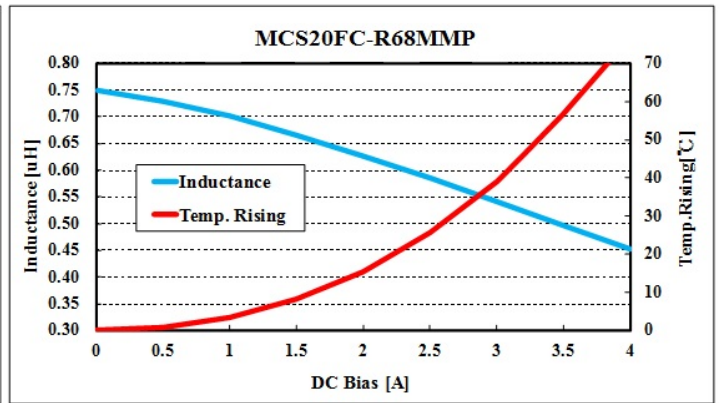
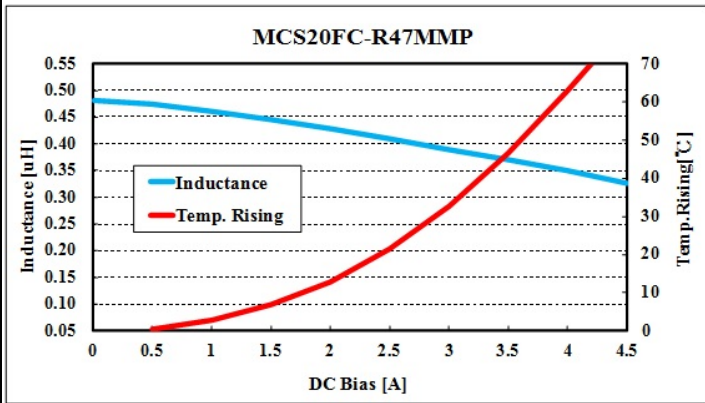
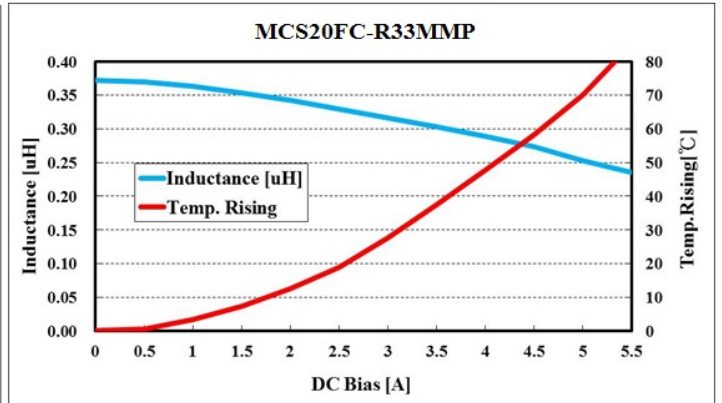
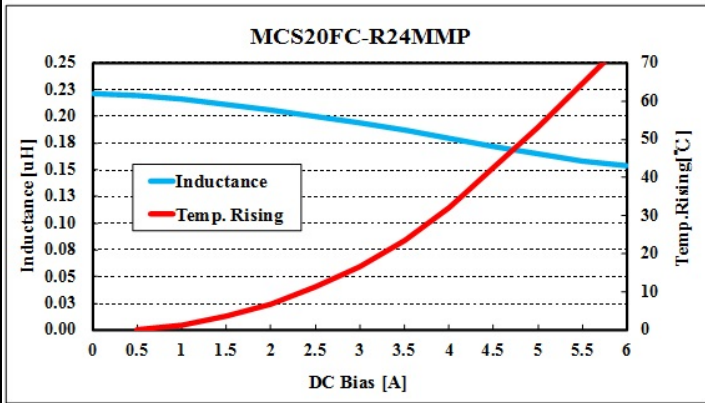

SPECIFICATION FOR APPROVAL

5. RELIABILITY PERFORMANCE

Test Item	Test Condition	Criteria
Resistance to Solder Heat	<ol style="list-style-type: none"> 1. Solder temperature: 260±5°C 2. Flux: Rosin 3. DIP time: 10±1 sec 	<ol style="list-style-type: none"> 1. More than 95% of terminal electrode should be covered with new solder 2. No mechanical damage 3. Inductance value should be within ±20% of the initial value
Adhesive Test	<ol style="list-style-type: none"> 1. Reflow temperature: 245°C It shall be Soldered on the substrate applying direction parallel to the substrate 2. Apply force(F): 5N 3. Test time: 10 sec 	<ol style="list-style-type: none"> 1. No mechanical damage 2. Soldering the products on PCB after the pulling test force > 5N
Temperature Cycle	<ol style="list-style-type: none"> 1. Temperature: -50 ~ 125°C For 30 minutes each 2. Cycle: 500 cycles 3. Measurement: At ambient temperature 24 hours after test completion 	<ol style="list-style-type: none"> 1. No mechanical damage 2. Inductance should be within ±20% of the initial value
Dry Heat Test	<ol style="list-style-type: none"> 1. Temperature: 85±2°C 2. Testing time: 500 hrs 3. Applied current: Full rated current 4. Measurement: At ambient temperature 24 hours after test completion 	<ol style="list-style-type: none"> 1. No mechanical damage 2. Inductance should be within ±20% of the initial value
Humidity Test	<ol style="list-style-type: none"> 1. Temperature: 60±2°C 2. Humidity: 90-95 % RH 3. Applied current: Full rated current 4. Testing time: 500 hrs 5. Measurement: At ambient temperature 24 hours after test completion 	<ol style="list-style-type: none"> 1. No mechanical damage 2. Inductance should be within ±20% of the initial value

SPECIFICATION FOR APPROVAL

6. TYPICAL RoHS REFLOW PROFILE

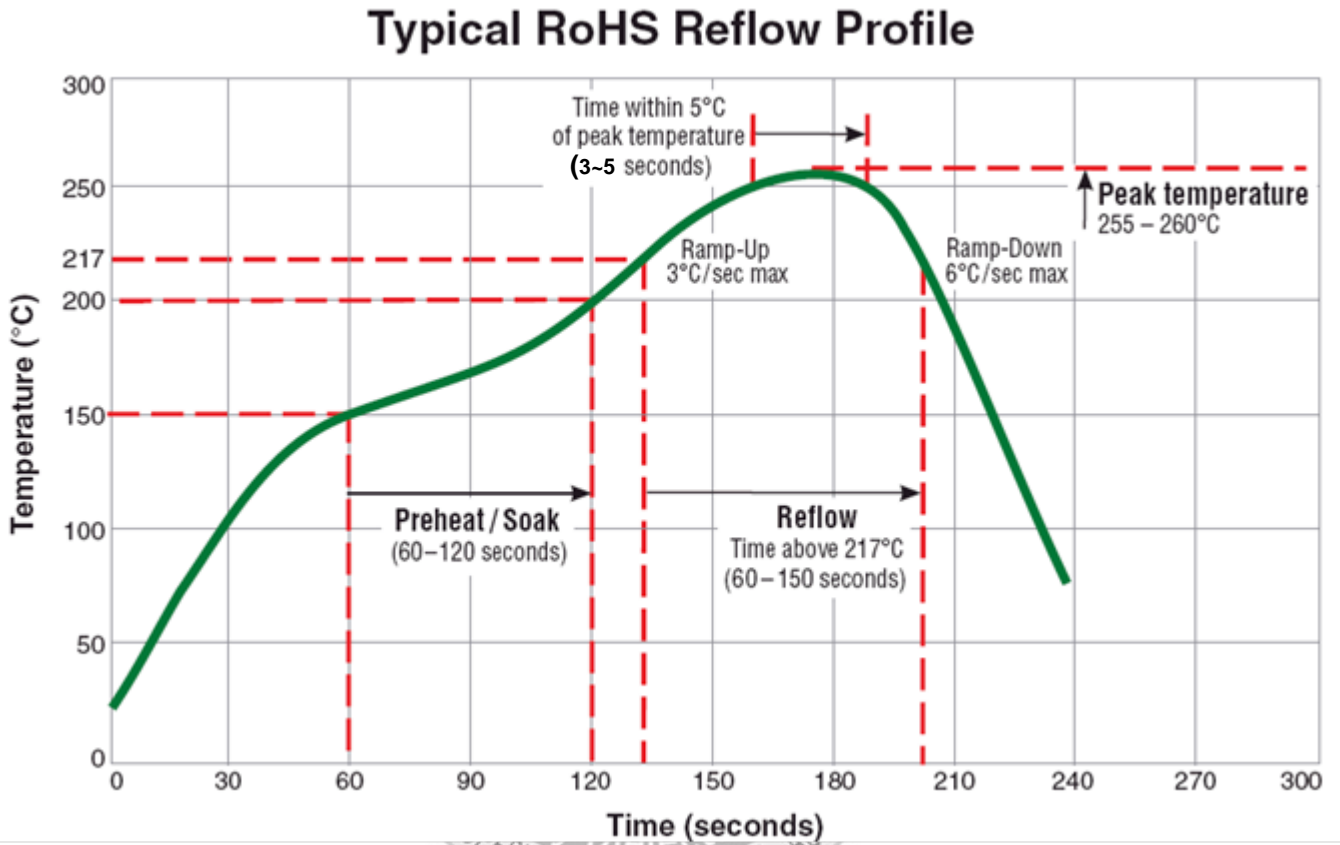

ERITY DIELECTRICS CO., LTD. H.K.

SPECIFICATION FOR APPROVAL

7. PACKING

7.1 Carrier tape dimensions

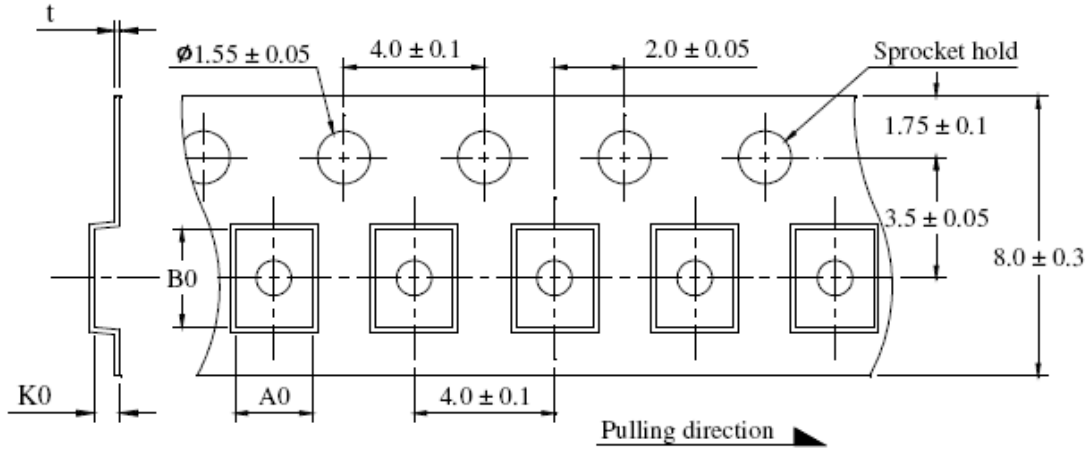

UNIT : mm

	A0	B0	K0	t
DIM.	1.80±0.1	2.20±0.1	1.15±0.1	0.22±0.05

7.2 Taping reel dimensions

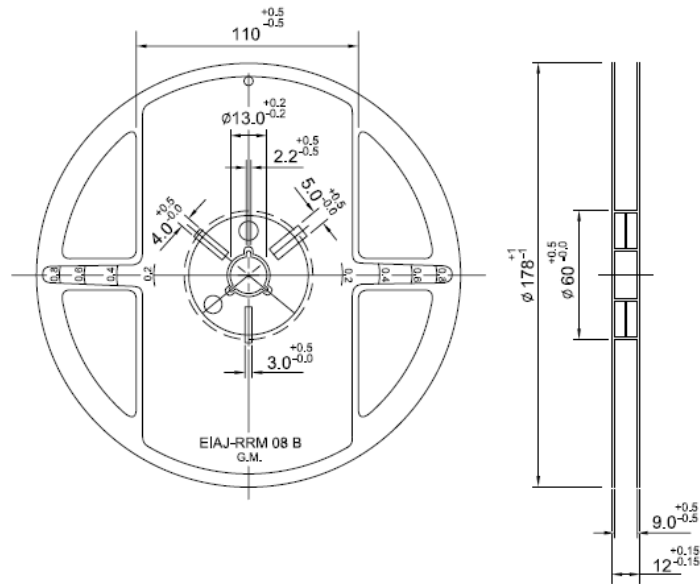

Qty.(pcs)	3,000
BOX	5 reels / inner box