

SPECIFICATION FOR APPROVAL

CUSTOMER	_____
CUST. PART NO.	_____
CUST. DOC. REV.	_____
DESCRIPTION	MOLDED POWER CHOKE (RoHS+H.F.)
SAMPLE LOT NO.	_____
PART NO.	MCS20FC-XXXMHC
DOC. REV.	ORIG
DATE	_____

Once you approve this part, please sign and return this page to the following marked location.

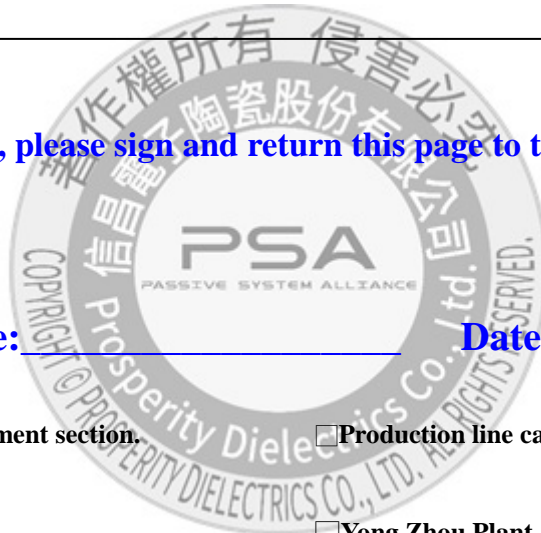

Customer Signature: _____ **Date:** _____

This part currently development section. Production line can produce this series of products.

Sales Office-Headquarter

No. 566-1, Kao-Shi Rd., Yangmei, Taoyuan 32668,
Taiwan
TEL: +886-3-475-3355
FAX: +886-3-485-4959

Yong Zhou Plant

Tao-Yuan Rd., Fenghuang Park, Lengshuitan
District, Yongzhou, Hunan 425000, P.R.C.
TEL: +86-746-8610-180
FAX: +86-746-8610-181

Sales Office-Dong Guan,China

No.638,Mei Jing West Road Xiniupo Administrative
Zone Dalang Town,Dong Guan City,GuangDong
Province,China.
TEL: +86-769-8555-0979
FAX: +86-769-8555-0972

TESTED BY	CHECKED BY	APPROVED BY

TABLE OF CONTENTS

INDEX	Page
■ Engineering Change Notice - Record	2
■ Part Number Identification	3
■ Mechanical Dimension	3
■ Electrical Specification	3
■ Electrical Curve	4
■ Reliability Performance	5
■ Reflow Chart	6
■ Packing	7
■ Test Report	

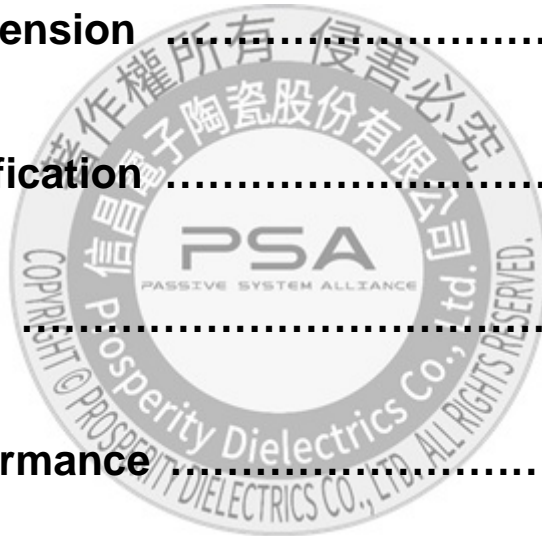

SPECIFICATION FOR APPROVAL

CUSTOMER	CUSTOMER P/N	REV. —	SPL. LOT NO.	
PART NAME MOLDED POWER CHOKE(RoHS+H.F.)	PART NO. MCS20FC-XXXMHC	REV. ORIG	DATE OF ISSUE	Q'TY 0 PCS

ENGINEERING CHANGE NOTICE - RECORD

REVISION NO.	REVISION DESCRIPTION	AUTHOR	DATE	REMARK
ORIG		Gary Chang		



SPECIFICATION FOR APPROVAL

✘ This is a RoHS and REACH compliant product whose related documents are available on request.
 ✘ Graphic is only for dimensionally application.

1. PART NUMBERING IDENTIFICATION

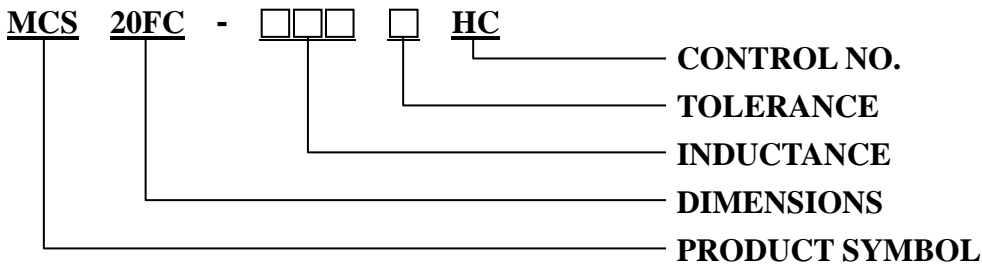

2. MECHANICAL DIMENSION

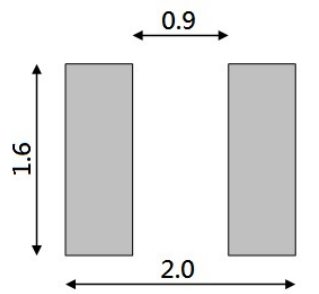
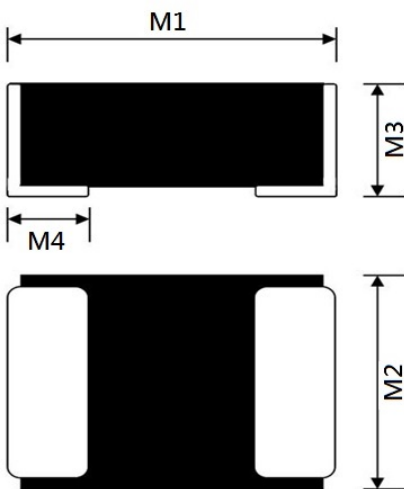

UNIT: mm

	DIM.	TOL.
M1	2.0	±0.2
M2	1.6	±0.2
M3	1.0	MAX.
M4	0.5	±0.3

3. ELECTRICAL SPECIFICATION

Part number	Inductance	DC Resistance	DC Resistance	Irms	Irms	I sat	I sat
	(uH) ±20%	(mΩ) Typical	(mΩ) MAX.	(A) Typical	(A) MAX.	(A) Typical	(A) MAX.
MCS20FC-R33MHC	0.33	21	26	4.7	4.0	6.7	6.1
MCS20FC-R47MHC	0.47	23	30	4.5	4.05	6.1	5.3
MCS20FC-1R0MHC	1.0	48	60	3.2	3.0	3.9	3.3
MCS20FC-1R5MHC	1.5	86	99	2.4	2.2	3.4	3.1
MCS20FC-2R2MHC	2.2	117	140	2.2	2.0	2.6	2.45

NOTE:

1. Test Freq.: 1MHz, 1V
2. All test referenced to 26°C ambient.
3. Operating Temperature range: -40°C to +125°C
4. Storage Temperature range: -50°C to +125°C
5. Isat means that DC current will cause a 30% inductance reduction from initial value.
6. Irms means that DC current will cause coil temp. rising to 40°C whichever is smaller.

SPECIFICATION FOR APPROVAL

4. ELECTRICAL CURVE

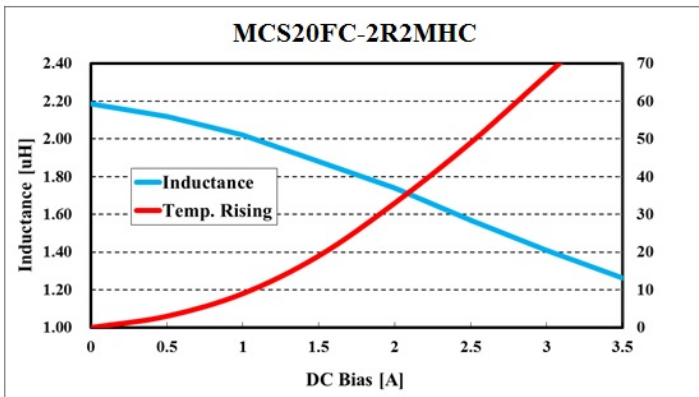
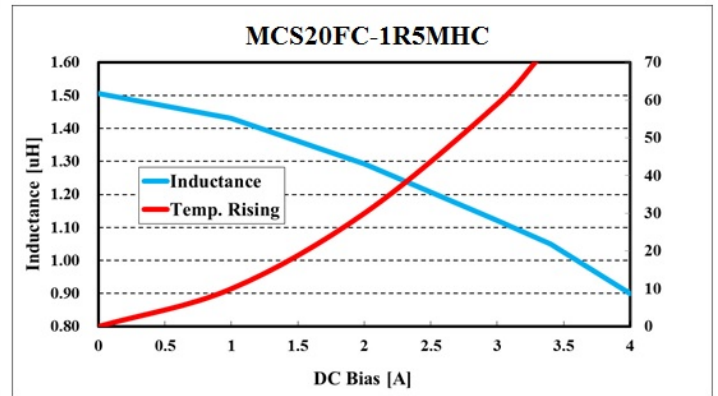
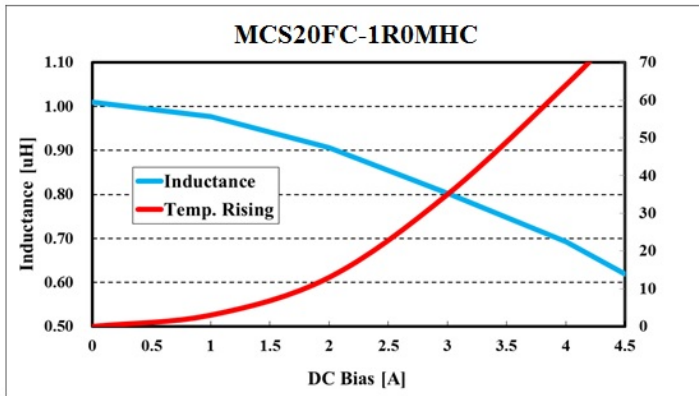
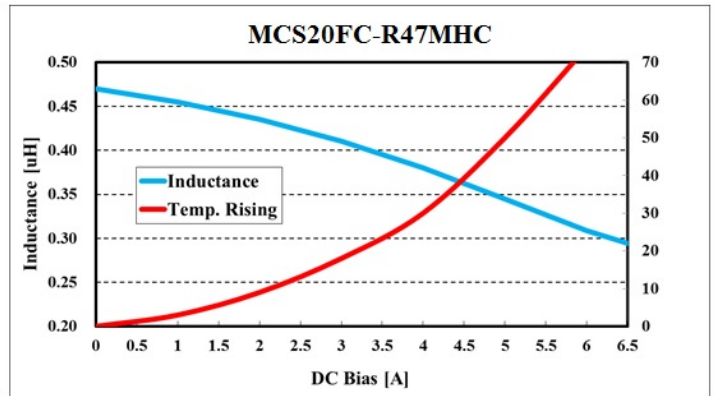
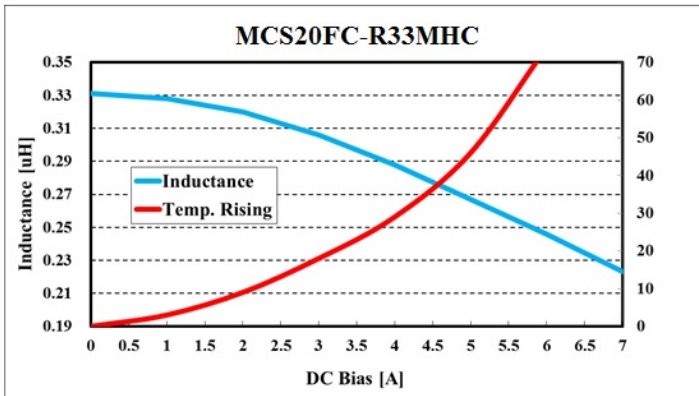

SPECIFICATION FOR APPROVAL

5. RELIABILITY PERFORMANCE

Test Item	Test Condition	Criteria
Resistance to Solder Heat	<ol style="list-style-type: none"> 1. Solder temperature: $260 \pm 5^{\circ}\text{C}$ 2. Flux: Rosin 3. DIP time: 10 ± 1 sec 	<ol style="list-style-type: none"> 1. More than 95% of terminal electrode should be covered with new solder 2. No mechanical damage 3. Inductance value should be within $\pm 20\%$ of the initial value
Adhesive Test	<ol style="list-style-type: none"> 1. Reflow temperature: 245°C It shall be Soldered on the substrate applying direction parallel to the substrate 2. Apply force(F): 5N 3. Test time: 10 sec 	<ol style="list-style-type: none"> 1. No mechanical damage 2. Soldering the products on PCB after the pulling test force $> 5\text{N}$
Temperature Cycle	<ol style="list-style-type: none"> 1. Temperature: $-50 \sim 125^{\circ}\text{C}$ For 30 minutes each 2. Cycle: 500 cycles 3. Measurement: At ambient temperature 24 hours after test completion 	<ol style="list-style-type: none"> 1. No mechanical damage 2. Inductance should be within $\pm 20\%$ of the initial value
Dry Heat Test	<ol style="list-style-type: none"> 1. Temperature: $85 \pm 2^{\circ}\text{C}$ 2. Testing time: 500 hrs 3. Applied current: Full rated current 4. Measurement: At ambient temperature 24 hours after test completion 	<ol style="list-style-type: none"> 1. No mechanical damage 2. Inductance should be within $\pm 20\%$ of the initial value
Humidity Test	<ol style="list-style-type: none"> 1. Temperature: $60 \pm 2^{\circ}\text{C}$ 2. Humidity: 90-95% RH 3. Applied current: Full rated current 4. Testing time: 500 hrs 5. Measurement: At ambient temperature 24 hours after test completion 	<ol style="list-style-type: none"> 1. No mechanical damage 2. Inductance should be within $\pm 20\%$ of the initial value

SPECIFICATION FOR APPROVAL

6. TYPICAL RoHS REFLOW PROFILE

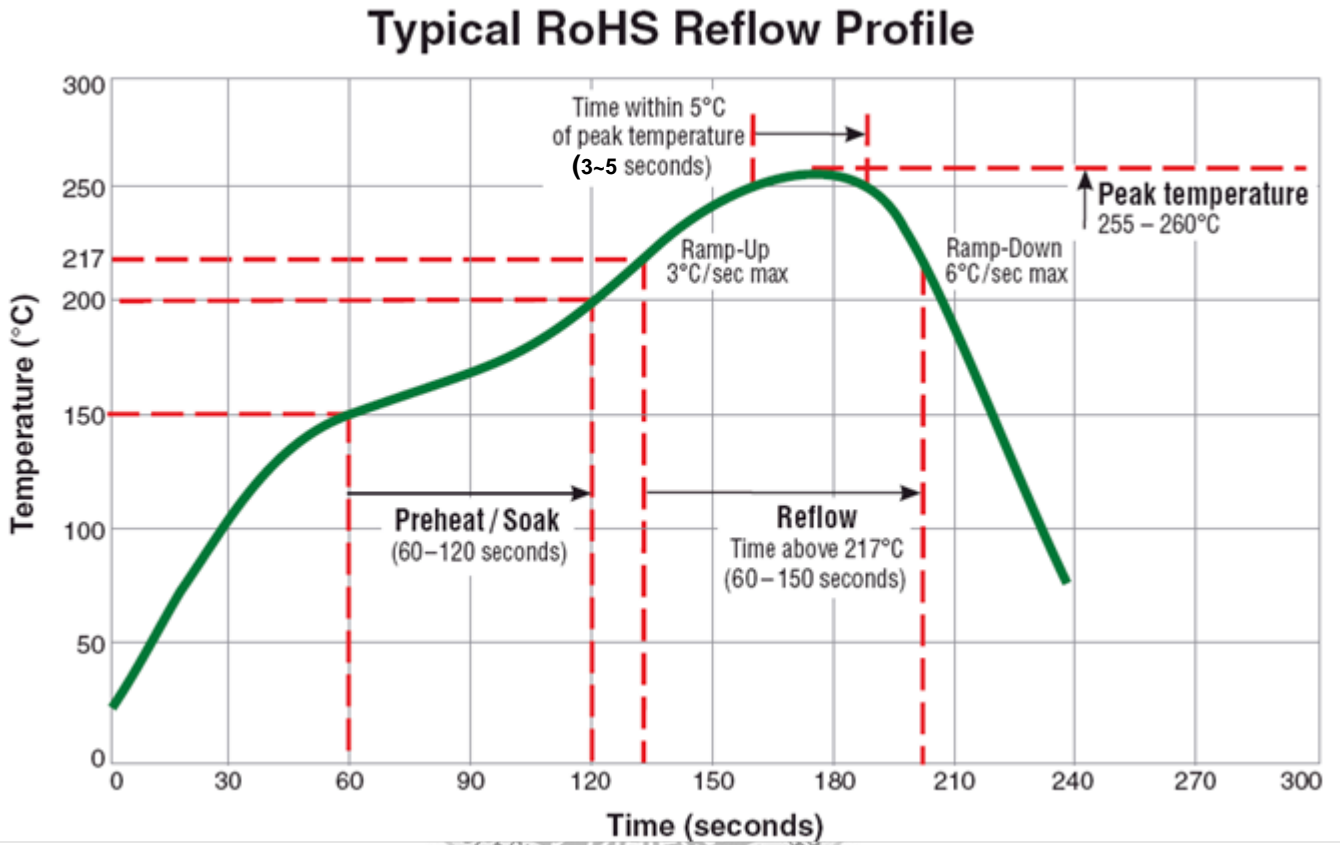

SPECIFICATION FOR APPROVAL

7. PACKING

7.1 Carrier tape dimensions

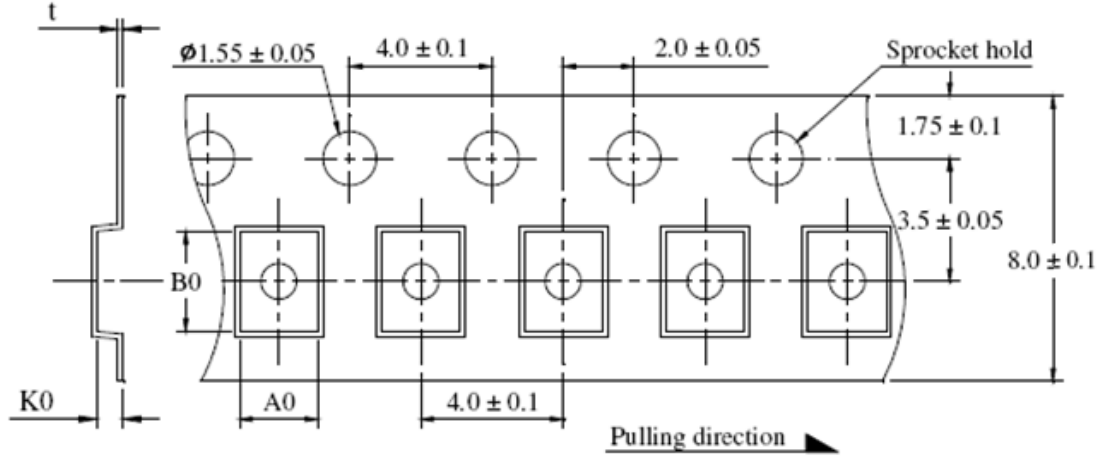

UNIT : mm

	A0	B0	K0	t
DIM.	1.82±0.05	2.23±0.05	1.15±0.05	0.22±0.05

7.2 Taping reel dimensions

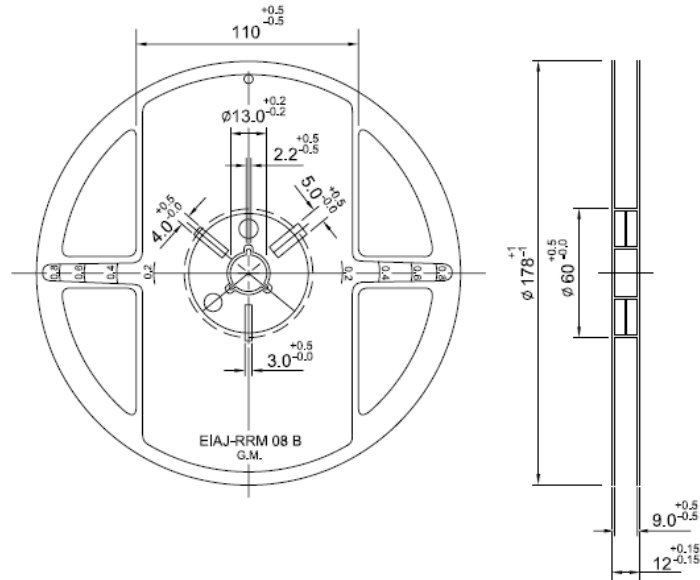

Qty.(pcs)	3,000
BOX	5 reels / inner box