

DC/DC REGULATORS

The SCI7710Y family of CMOS voltage regulators comprises two series – the SCI7710Y series for positive input voltages and the SCI7711Y series for negative input voltages.

■ DESCRIPTION

SCI7710Y series voltage regulators provide step-down and stabilization of an input voltage to a specified fixed voltage. The nine devices in the series incorporate a precision, power-saving reference voltage generator, a transistorized differential amplifier and resistors for determining the output voltage. The SCI7710Y series is available in 3-pin plastic SOT89s.

■ APPLICATIONS

- Fixed-voltage power supplies for battery-operated equipment such as portable video cassette recorders, video cameras and radios
- Fixed-voltage power supplies for communications equipment
- High-stability reference voltage generators

■ FEATURES

- 1.5 μ A (typ) current consumption (SCI7710YHA)
- -1.8 mV/deg. C (typ) temperature gradient (SCI7710YDA)
- Wide range of operating voltages
- 0.5 %/V (typ) input stability (SCI7710YDA)
- On-chip reference voltage generator
- On-chip differential amplifier
- 3-pin plastic SOT89

■ SCI7710Y Series/SCI7711Y Series

Device	Voltage (V)		Output current (mA)	Current consumption (μ A)	Operating temperature (deg. C)
	Input	Output			
SCI7710YHA	15 (max)	1.5	10 at VI = 3V	1.5	-30 to 85
SCI7710YGA		1.8	10 at VI = 3V	1.6	
SCI7710YFA		2.2	10 at VI = 3V	1.8	
SCI7710YLA		2.6	30 at VI = 4V	2.0	
SCI7710YDA		3.0	30 at VI = 5V	2.0	
SCI7710YCA		3.2	30 at VI = 5V	2.0	
SCI7710YKA		3.9	40 at VI = 6V	2.2	
SCI7710YMA		4.5	50 at VI = 6V	2.4	
SCI7710YBA		5.0	50 at VI = 7V	2.4	

September 1993

■ BLOCK DIAGRAM

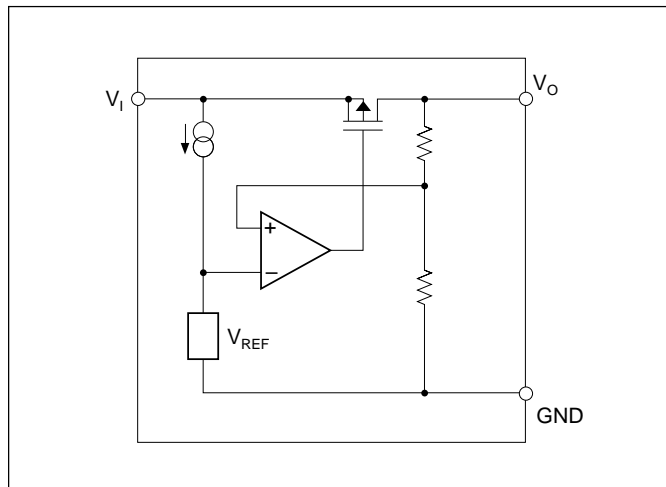

■ PIN CONFIGURATION

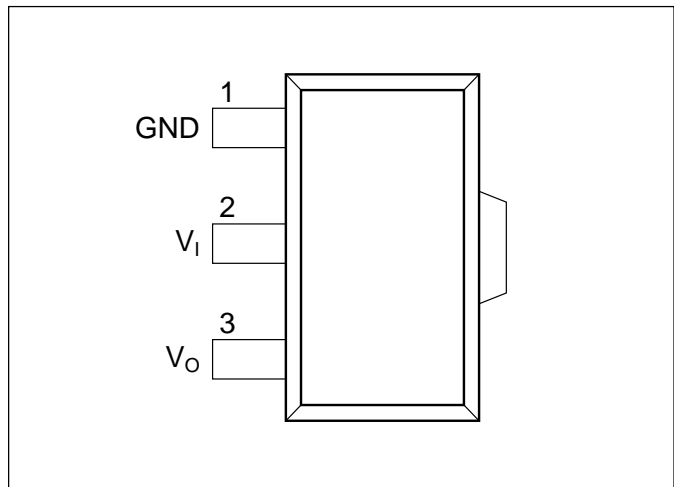

■ PIN DESCRIPTION

Number	Name	Description
1	GND	Ground
2	V _I	Input voltage
3	V _O	Output voltage

■ ABSOLUTE MAXIMUM RATINGS

Parameter	Symbol	Ratings	Unit
Input voltage	V _I	21	V
Output current	I _O	100	mA
Output voltage range	V _O	V _I + 0.3 to GND - 0.3	V
Power dissipation (T _a ≤ 25°C)	P _D	400	mW
Operating temperature	T _{OPR}	-20 to 70	°C
Storage temperature	T _{STG}	-65 to 150	°C
Soldering temperature & time	T _{SOL}	260°C, 10s (at lead)	—

Note: Temperatures during reflow soldering must remain within the limits set out in LSI Device Precautions. Never use solder dip to mount SCI7000 series power supply devices.

■ **ELECTRICAL CHARACTERISTICS**

● **SCI7710YHA**

$V_{SS} = 0V$, $T_a = -20$ to $70^\circ C$, unless otherwise noted

Parameter	Symbol	Conditions	Rating			Unit
			Min	Typ	Max	
Input voltage	V_I		—	—	15.0	V
Output voltage	V_O	$V_I = 3.0V$, $I_o = 1mA$, $T_a = 25^\circ C$	1.40	1.50	1.60	V
		$V_I = 3.0V$ to $10.0V$, $I_o = 1mA$	1.35	—	1.65	
Input/output voltage differential	$ V_I - V_O $	$V_I = 1.5V$, $I_o = 1mA$	—	55.0	120	mV
Input voltage stabilization ratio	$\frac{ \Delta V_O }{ \Delta V_I \cdot V_O }$	$V_I = 3.0V$ to $10.0V$, $I_o = 1$ to $10mA$, Isothermal	—	0.10	—	% / V
Operating current	I_{DDO}	$V_I = 1.8V$ to $15.0V$, $T_a = 25^\circ C$	—	1.50	4.0	μA
Temperature gradient	K_t		—	-1.0	—	mV/ $^\circ C$
Output voltage drift	ΔV_O	$V_I = 3.0V$, $I_o = 1$ to $10mA$, $T_a = 25^\circ C$	—	10.0	—	mV

● **SCI7710YGA**

$V_{SS} = 0V$, $T_a = -20$ to $70^\circ C$, unless otherwise noted

Parameter	Symbol	Conditions	Rating			Unit
			Min	Typ	Max	
Input voltage	V_I		—	—	15.0	V
Output voltage	V_O	$V_I = 3.0V$, $I_o = 1mA$, $T_a = 25^\circ C$	1.70	1.80	1.90	V
		$V_I = 3.0V$ to $10.0V$, $I_o = 1mA$	1.60	—	2.0	
Input/output voltage differential	$ V_I - V_O $	$V_I = 1.8V$, $I_o = 1mA$	—	50.0	100	mV
Input voltage stabilization ratio	$\frac{ \Delta V_O }{ \Delta V_I \cdot V_O }$	$V_I = 3.0V$ to $10.0V$, $I_o = 1$ to $10mA$, Isothermal	—	0.10	—	% / V
Operating current	I_{DDO}	$V_I = 1.8V$ to $15.0V$, $T_a = 25^\circ C$	—	1.60	4.10	μA
Temperature gradient	K_t		—	-1.10	—	mV/ $^\circ C$
Output voltage drift	ΔV_O	$V_I = 3.0V$, $I_o = 1$ to $10mA$, $T_a = 25^\circ C$	—	10.0	—	mV

September 1993

■ ELECTRICAL CHARACTERISTICS (Cont.)

● SCI7710YFA

$V_{SS} = 0V$, $T_a = -20$ to $70^\circ C$, unless otherwise noted

Parameter	Symbol	Conditions	Rating			Unit
			Min	Typ	Max	
Input voltage	V_I		—	—	15.0	V
Output voltage	V_O	$V_I = 3.0V$, $I_o = 10mA$, $T_a = 25^\circ C$	2.10	2.20	2.30	V
		$V_I = 3.0V$ to $10.0V$, $I_o = 10mA$	2.0	—	2.40	
Input/output voltage differential	$ V_I - V_O $	$V_I = 2.2V$, $I_o = 1mA$	—	40.0	80.0	V
Input voltage stabilization ratio	$\frac{ \Delta V_O }{ \Delta V_I \cdot V_O }$	$V_I = 3.0V$ to $10.0V$, $I_o = 1$ to $10mA$, Isothermal	—	0.10	—	% / V
Operating current	I_{DDO}	$V_I = 2.2V$ to $15.0V$, $T_a = 25^\circ C$	—	1.80	4.30	μA
Temperature gradient	K_t		—	-1.30	—	$mV/^\circ C$
Output voltage drift	ΔV_O	$V_I = 3.0V$, $I_o = 1$ to $10mA$, $T_a = 25^\circ C$	—	25.0	—	mV

● SCI7710YLA

$V_{SS} = 0V$, $T_a = -20$ to $70^\circ C$, unless otherwise noted

Parameter	Symbol	Conditions	Rating			Unit
			Min	Typ	Max	
Input voltage	V_I		—	—	15.0	V
Output voltage	V_O	$V_I = 5.0V$, $I_o = 10mA$, $T_a = 25^\circ C$	2.45	2.60	2.75	V
		$V_I = 5.0V$ to $15.0V$, $I_o = 10mA$	2.30	—	2.90	
Input/output voltage differential	$ V_I - V_O $	$V_I = 2.45V$, $I_o = 10mA$	—	0.4	0.8	V
Input voltage stabilization ratio	$\frac{ \Delta V_O }{ \Delta V_I \cdot V_O }$	$V_I = 5.0V$ to $15.0V$, $I_o = 1$ to $10mA$, Isothermal	—	0.20	—	% / V
Operating current	I_{DDO}	$V_I = 3.0V$ to $15.0V$, $T_a = 25^\circ C$	—	2.0	4.5	μA
Temperature gradient	K_t	$I_o = 1$ to $30mA$	—	-1.6	—	$mV/^\circ C$
Output voltage drift	ΔV_O	$V_I = 5.0V$, $I_o = 1$ to $30mA$, $T_a = 25^\circ C$	—	30.0	—	mV

■ **ELECTRICAL CHARACTERISTICS (Cont.)**

● **SCI7710YDA**

$V_{SS} = 0V$, $T_a = -20$ to $70^\circ C$, unless otherwise noted

Parameter	Symbol	Conditions	Rating			Unit
			Min	Typ	Max	
Input voltage	V_I		—	—	15.0	V
Output voltage	V_O	$V_I = 5.0V$, $I_o = 10mA$, $T_a = 25^\circ C$	2.85	3.0	3.15	V
		$V_I = 4.0V$ to $15.0V$, $I_o = 10mA$	2.70	—	3.30	
		$V_I = 5.0V$ to $15.0V$, $I_o = 30mA$	2.70	—	3.30	
Input/output voltage differential	$ V_I - V_O $	$V_I = 3.0V$, $I_o = 10mA$	—	0.35	0.50	V
		$V_I = 3.0V$, $I_o = 30mA$	—	1.20	1.70	
Input voltage stabilization ratio	$\frac{ \Delta V_O }{ \Delta V_I \cdot V_O }$	$V_I = 4.0V$ to $15.0V$, $I_o = 1$ to $10mA$, Isothermal	—	0.15	—	% / V
Operating current	I_{DDO}	$V_I = 3.0V$ to $15.0V$, $T_a = 25^\circ C$	—	2.0	4.5	μA
Temperature gradient	K_t		—	-1.8	—	$mV/^\circ C$
Output voltage drift	ΔV_O	$V_I = 5.0V$, $I_o = 1$ to $30mA$	—	30.0	—	mV

● **SCI7710YCA**

$V_{SS} = 0V$, $T_a = -20$ to $70^\circ C$, unless otherwise noted

Parameter	Symbol	Conditions	Rating			Unit
			Min	Typ	Max	
Input voltage	V_I		—	—	15.0	V
Output voltage	V_O	$V_I = 5.0V$, $I_o = 10mA$, $T_a = 25^\circ C$	3.05	3.20	3.35	V
		$V_I = 4.0V$ to $15.0V$, $I_o = 10mA$	2.90	—	3.50	
Input/output voltage differential	$ V_I - V_O $	$V_I = 3.2V$, $I_o = 10mA$	—	0.32	0.47	V
		$V_I = 3.2V$, $I_o = 30mA$	—	1.10	1.60	
Input voltage stabilization ratio	$\frac{ \Delta V_O }{ \Delta V_I \cdot V_O }$	$V_I = 4.0V$ to $10.0V$, $I_o = 1$ to $10mA$, Isothermal	—	0.10	—	% / V
Operating current	I_{DDO}	$V_I = 3.2V$ to $15.0V$, $T_a = 25^\circ C$	—	2.0	4.50	μA
Temperature gradient	K_t		—	-1.90	—	$mV/^\circ C$
Output voltage drift	ΔV_O	$V_I = 5.0V$, $I_o = 1$ to $30mA$, $T_a = 25^\circ C$	—	30.0	—	mV

September 1993

■ ELECTRICAL CHARACTERISTICS (Cont.)

● SCI7710YKA

$V_{SS} = 0V$, $T_a = -20$ to $70^\circ C$, unless otherwise noted

Parameter	Symbol	Conditions	Rating			Unit
			Min	Typ	Max	
Input voltage	V_i		—	—	15.0	V
Output voltage	V_o	$V_i = 6.0V$, $I_o = 5mA$, $T_a = 25^\circ C$	3.79	3.90	4.01	V
Input/output voltage differential	$ V_i - V_o $	$V_i = 3.9V$, $I_o = 5mA$	—	0.15	0.30	V
Input voltage stabilization ratio	$\frac{ \Delta V_o }{ \Delta V_i \cdot V_o }$	$V_i = 5.0V$ to $10.0V$, $I_o = 1$ to $10mA$, Isothermal	—	0.20	—	% / V
Operating current	I_{DDO}	$V_i = 5.0V$ to $15.0V$, $T_a = 25^\circ C$	—	2.20	4.6	μA
Temperature gradient	K_t		—	-2.30	—	$mV/^\circ C$
Output voltage drift	ΔV_o	$V_i = 6.0V$, $I_o = 0.1$ to $5mA$, $T_a = 25^\circ C$	—	10.0	—	mV

● SCI7710YMA

$V_{SS} = 0V$, $T_a = -20$ to $70^\circ C$, unless otherwise noted

Parameter	Symbol	Conditions	Rating			Unit
			Min	Typ	Max	
Input voltage	V_i		—	—	15.0	V
Output voltage	V_o	$V_i = 6.0V$, $I_o = 10mA$, $T_a = 25^\circ C$	4.4	4.50	4.60	V
		$V_i = 6.0V$ to $15.0V$, $I_o = 10mA$	4.30	—	4.70	
Input/output voltage differential	$ V_i - V_o $	$V_i = 4.3V$, $I_o = 10mA$	—	0.25	0.40	V
Input voltage stabilization ratio	$\frac{ \Delta V_o }{ \Delta V_i \cdot V_o }$	$V_i = 6.0V$ to $15.0V$, $I_o = 1$ to $10mA$, Isothermal	—	0.2	—	% / V
Operating current	I_{DDO}	$V_i = 5.0V$ to $15.0V$, $T_a = 25^\circ C$	—	2.4	4.8	μA
Temperature gradient	K_t		—	-2.7	—	$mV/^\circ C$
Output voltage drift	ΔV_o	$V_i = 6.0V$, $I_o = 0.1$ to $30mA$, $T_a = 25^\circ C$	—	30.0	—	mV

■ **ELECTRICAL CHARACTERISTICS (Cont.)**

● **SCI7710YBA**

$V_{SS} = 0V$, $T_a = -20$ to $70^\circ C$, unless otherwise noted

Parameter	Symbol	Conditions	Rating			Unit
			Min	Typ	Max	
Input voltage	V_i		—	—	15.0	V
Output voltage	V_o	$V_i = 7.0V$, $I_o = 10mA$, $T_a = 25^\circ C$	4.75	5.00	5.25	V
		$V_i = 6.0V$ to $15.0V$, $I_o = 10mA$	4.50	—	5.50	
		$V_i = 7.2V$ to $15.0V$, $I_o = 50mA$	4.50	—	5.50	
Input/output voltage differential	$ V_i - V_o $	$V_i = 5.0V$, $I_o = 10mA$	—	0.25	0.35	V
		$V_i = 5.0V$, $I_o = 30mA$	—	1.35	1.70	
Input voltage stabilization ratio	$\frac{ \Delta V_o }{ \Delta V_i \cdot V_o }$	$V_i = 6.0V$ to $15.0V$, $I_o = 1$ to $10mA$, Isothermal	—	0.18	—	% / V
Operating current	I_{DDO}	$V_i = 5.0V$ to $15.0V$, $T_a = 25^\circ C$	—	2.40	4.80	μA
Temperature gradient	K_t		—	-3.0	—	$mV/^\circ C$
Output voltage drift	ΔV_o	$V_i = 7.0V$, $I_o = 1$ to $50mA$, $T_a = 25^\circ C$	—	50.0	—	mV

September 1993

■ TYPICAL PERFORMANCE CHARACTERISTICS

● SCI7710YHA

Output voltage vs. input voltage

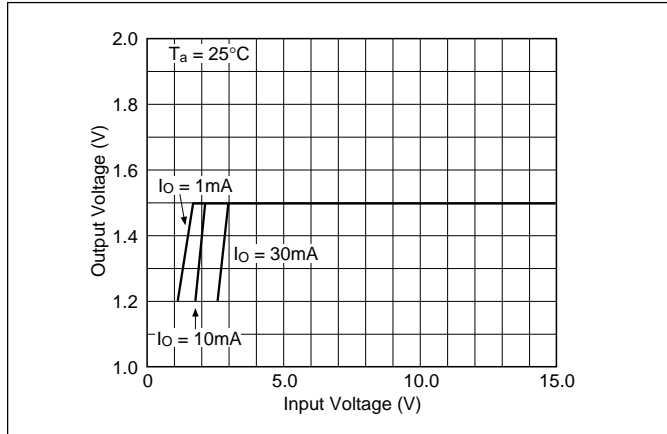

Input/output voltage differential vs. ambient temperature

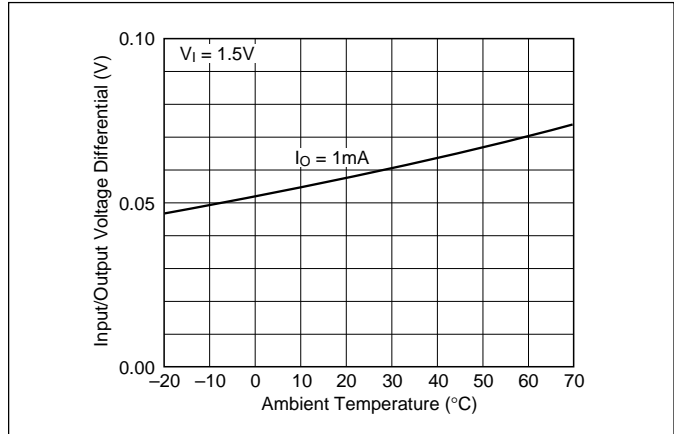

Operating current vs. ambient temperature

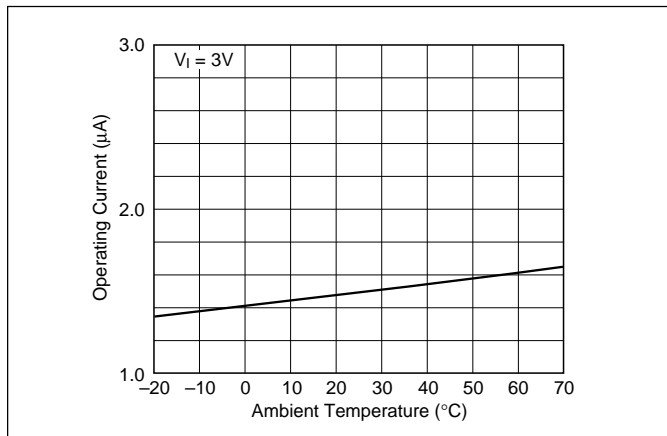

Operating current vs Input voltage

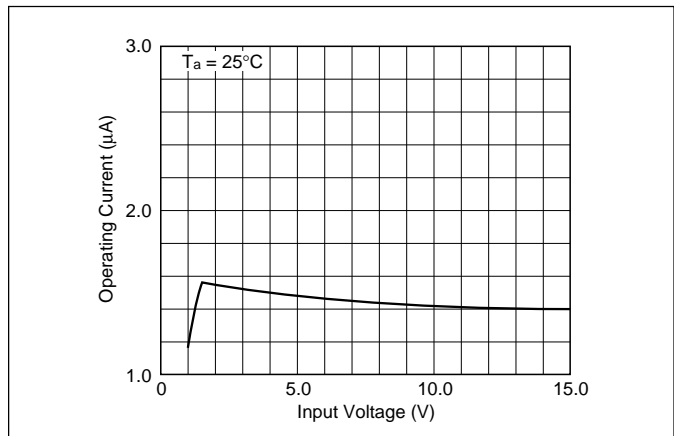

Output voltage vs. ambient temperature

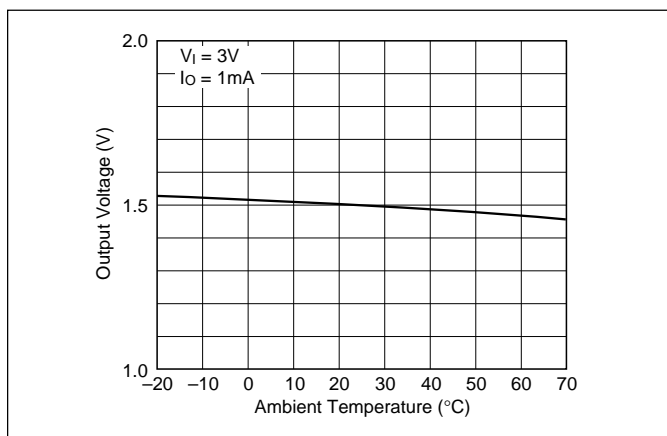

Output voltage drift vs. ambient temperature

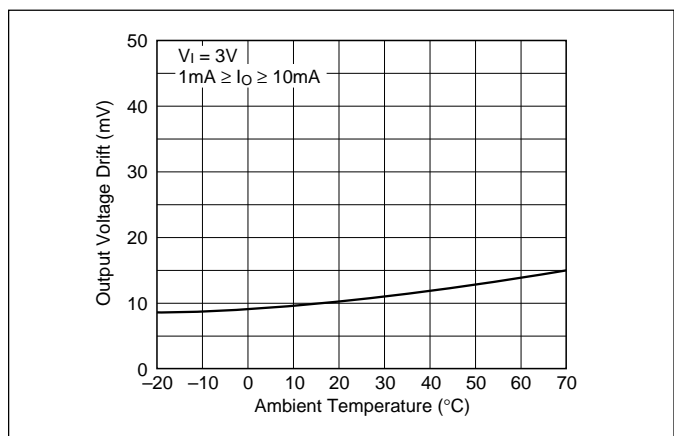

TYPICAL PERFORMANCE CHARACTERISTICS (CONT.)

● SCI7710YGA

Output voltage vs. input voltage

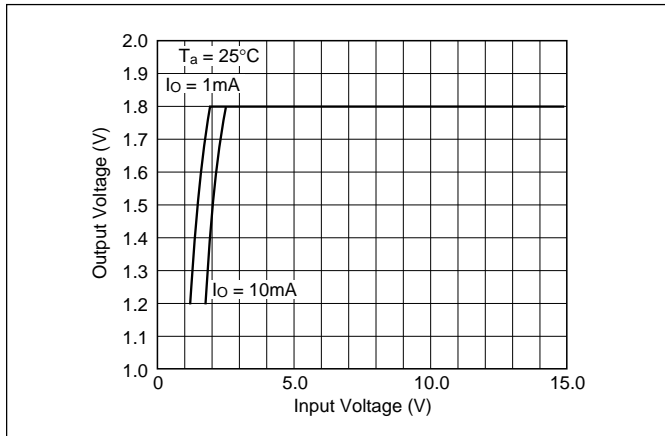

Input/output voltage differential vs. ambient temperature

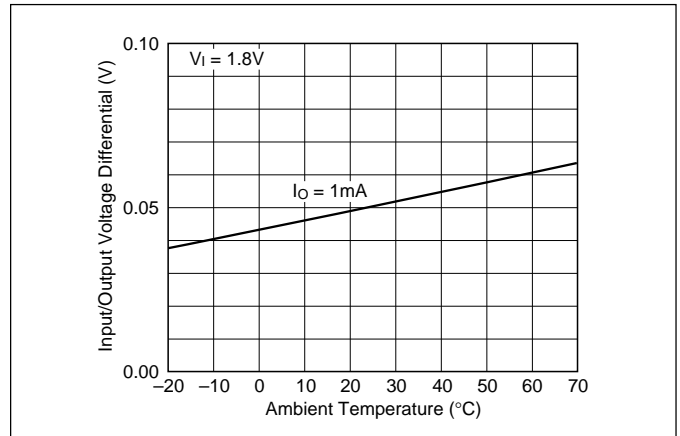

Operating current vs. ambient temperature

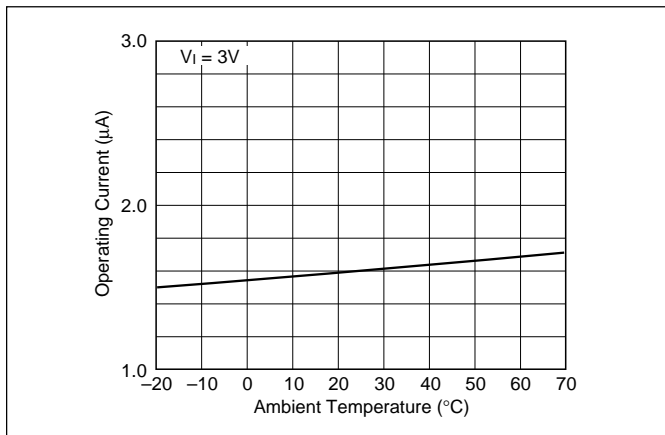

Operating current vs Input voltage

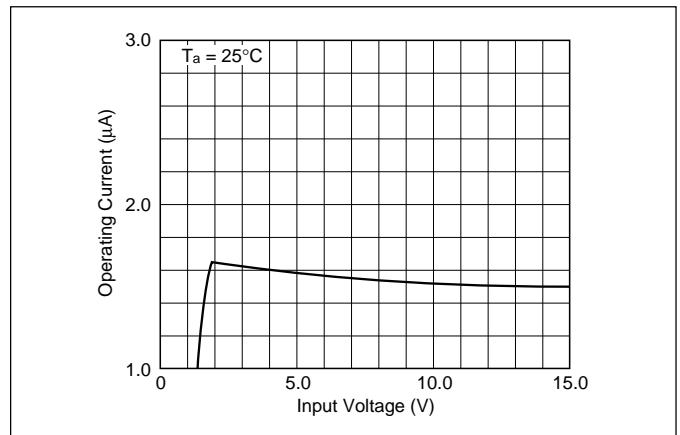

Output voltage vs. ambient temperature

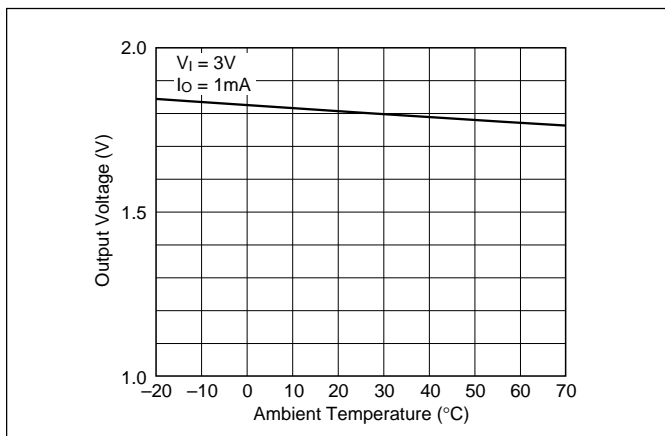

Output voltage drift vs. ambient temperature

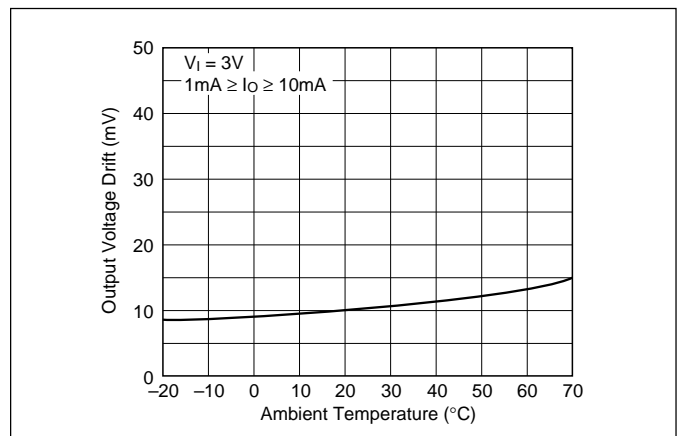

September 1993

■ TYPICAL PERFORMANCE CHARACTERISTICS (CONT.)

● SCI7710YFA

Output voltage vs. input voltage

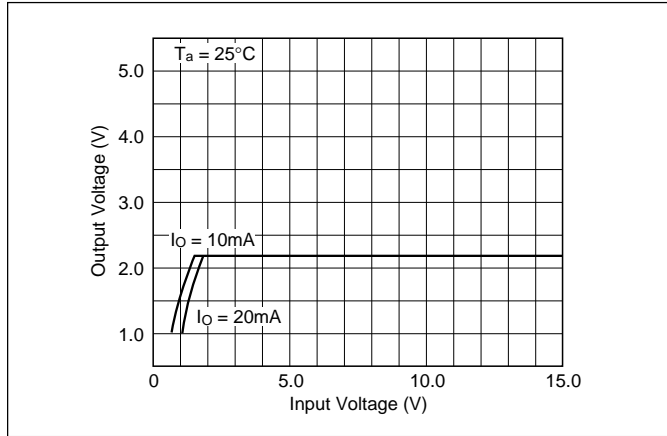

Input/output voltage differential vs. ambient temperature

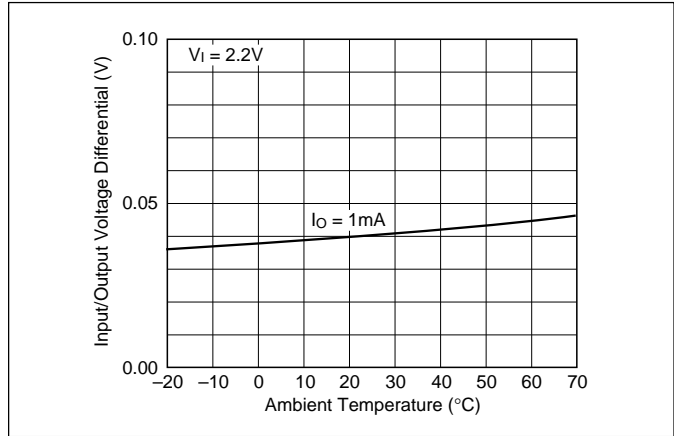

Operating current vs. ambient temperature

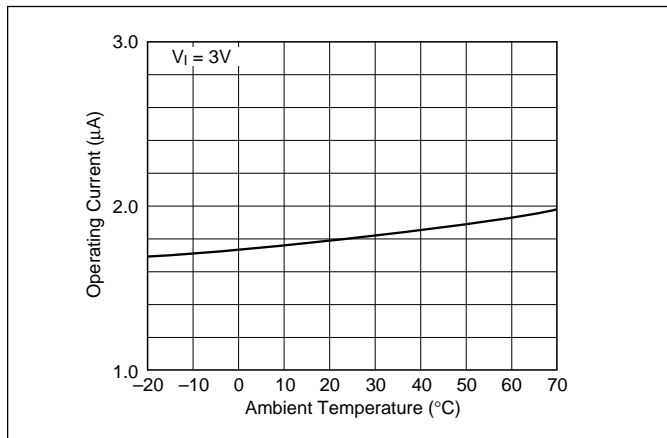

Operating current vs Input voltage

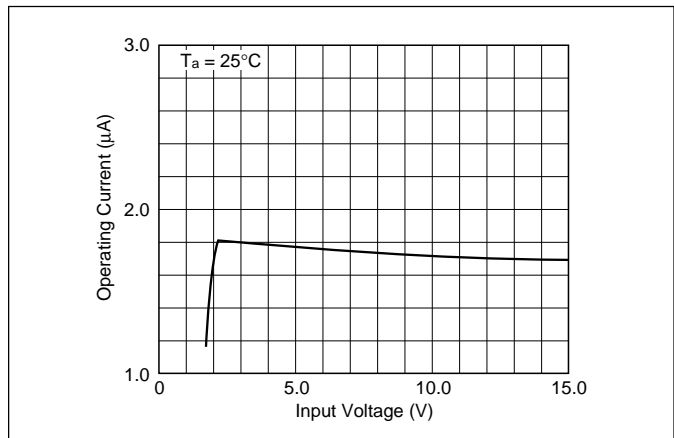

Output voltage vs. ambient temperature

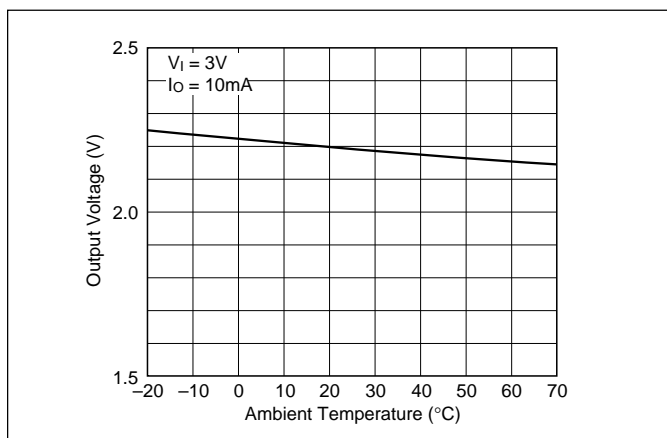

Output voltage drift vs. ambient temperature

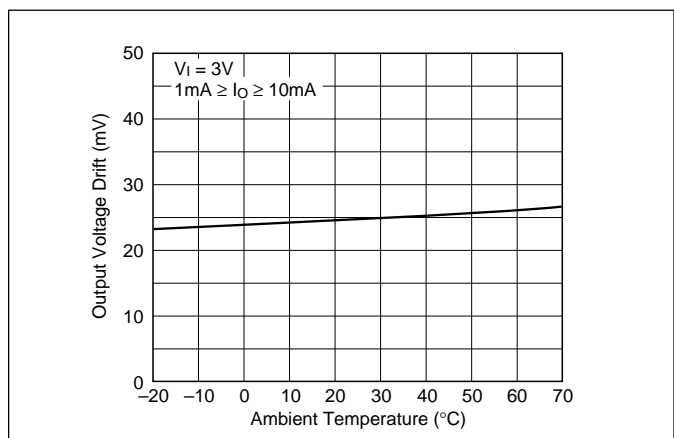

TYPICAL PERFORMANCE CHARACTERISTICS (CONT.)

● SCI7710YLA

Output voltage vs. input voltage

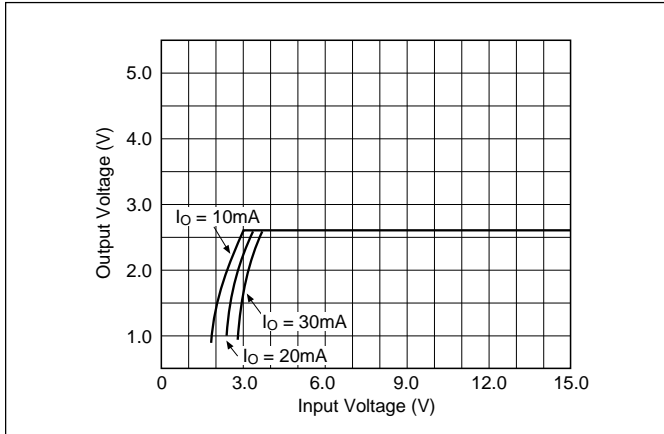

Input/output voltage differential vs. ambient temperature

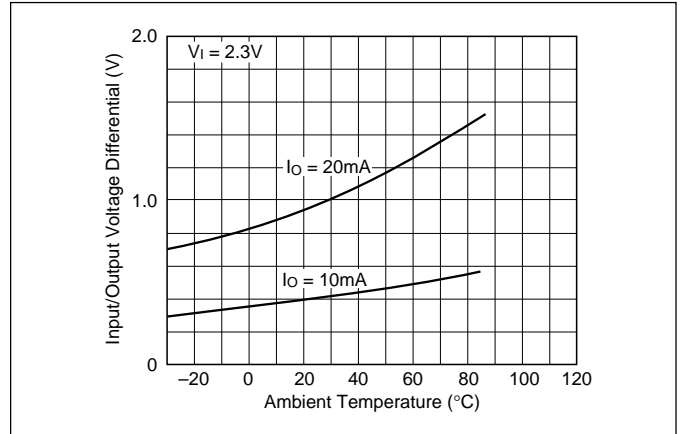

Operating current vs. ambient temperature

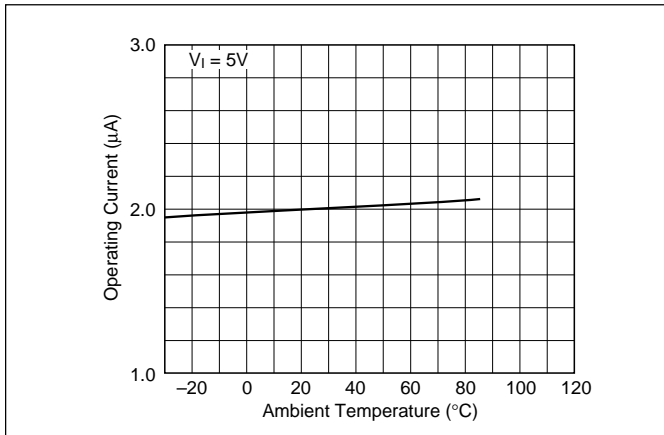

Operating current vs Input voltage

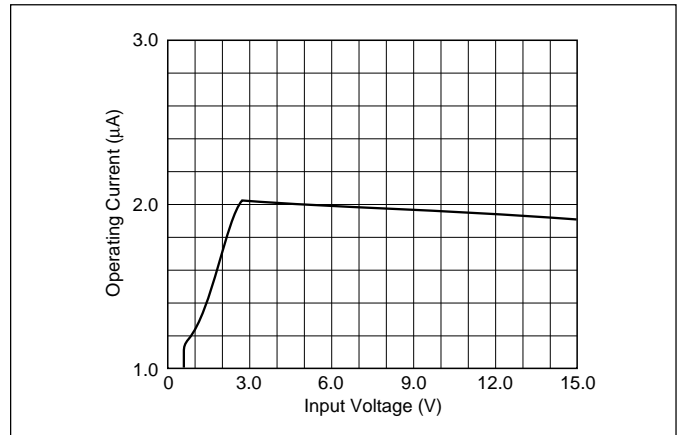

Output voltage vs. ambient temperature

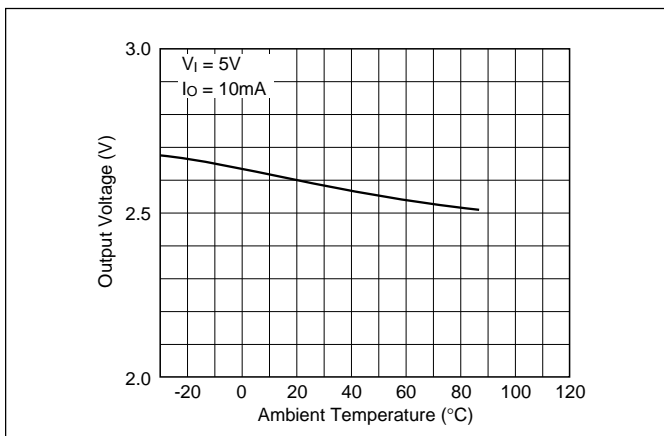

Output voltage drift vs. ambient temperature

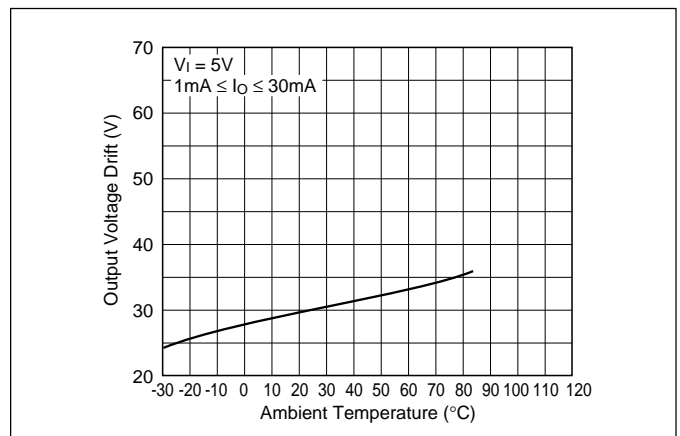

September 1993

■ TYPICAL PERFORMANCE CHARACTERISTICS (CONT.)

● SCI7710YDA

Output voltage vs. input voltage

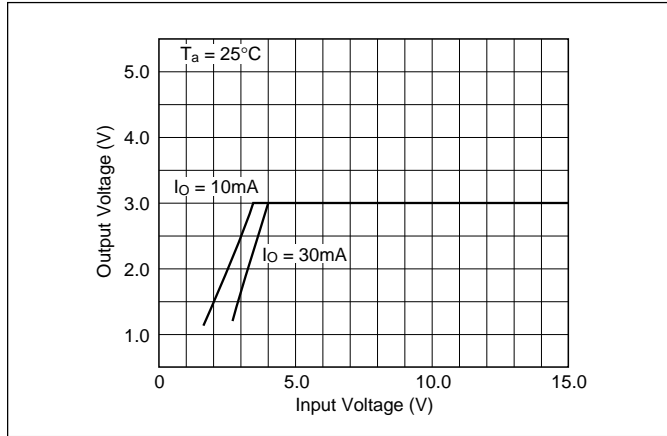

Input/output voltage differential vs. ambient temperature

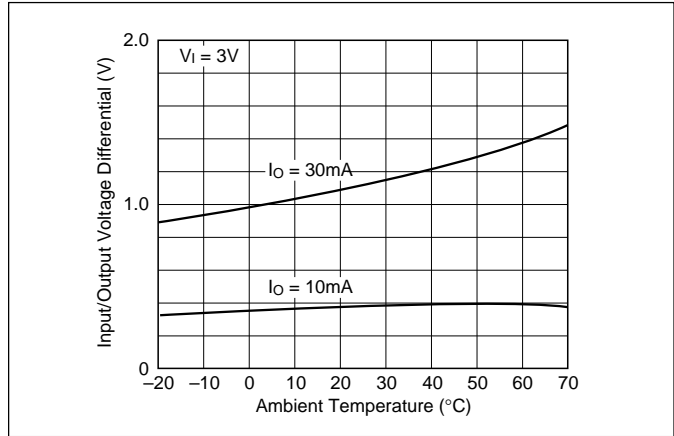

Operating current vs. ambient temperature

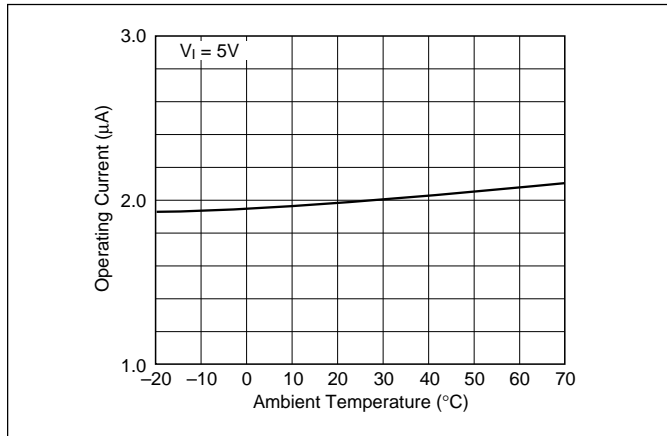

Operating current vs Input voltage

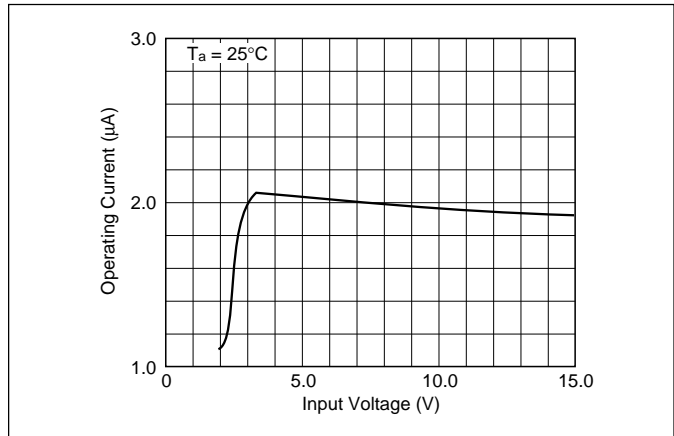

Output voltage vs. ambient temperature

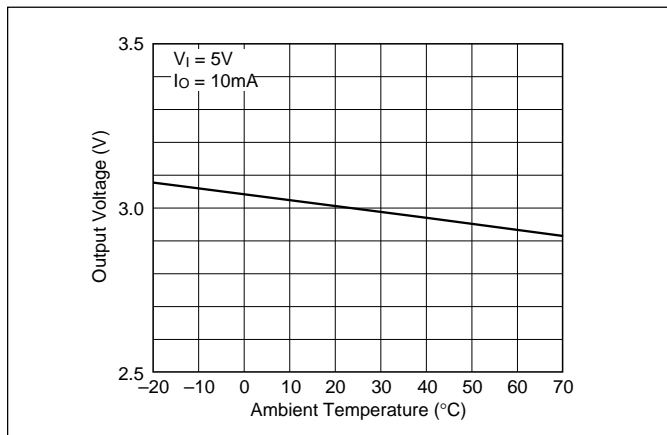

Output voltage drift vs. ambient temperature

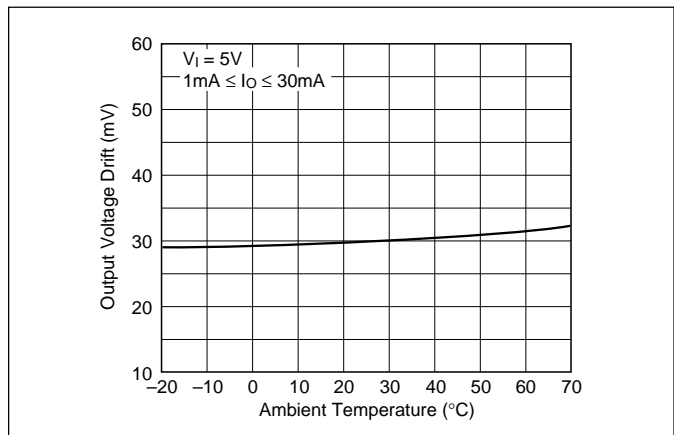

■ **TYPICAL PERFORMANCE CHARACTERISTICS (CONT.)**

● **SCI7710YCA**

Output voltage vs. input voltage

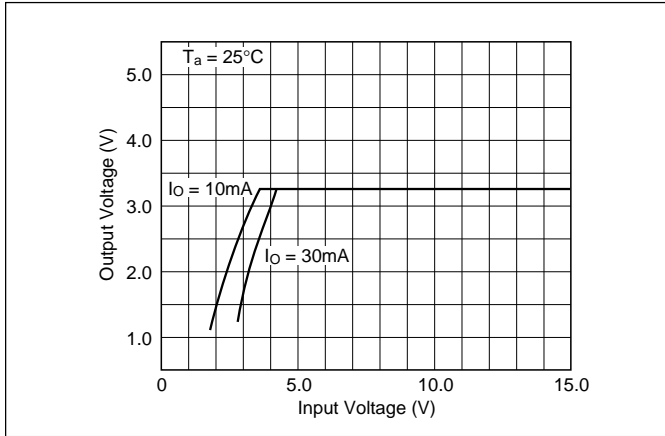

Input/output voltage differential vs. ambient temperature

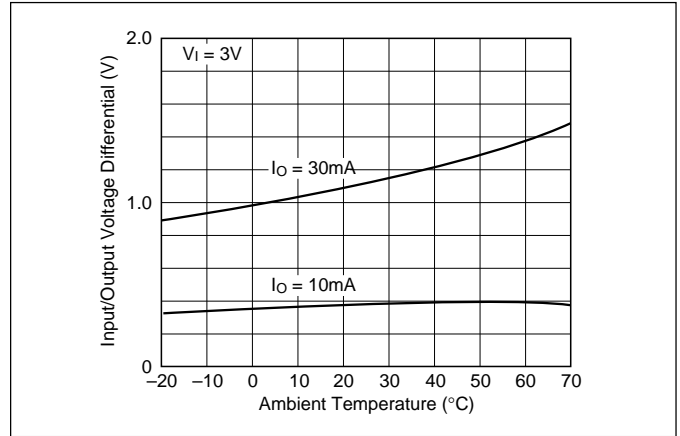

Operating current vs. ambient temperature

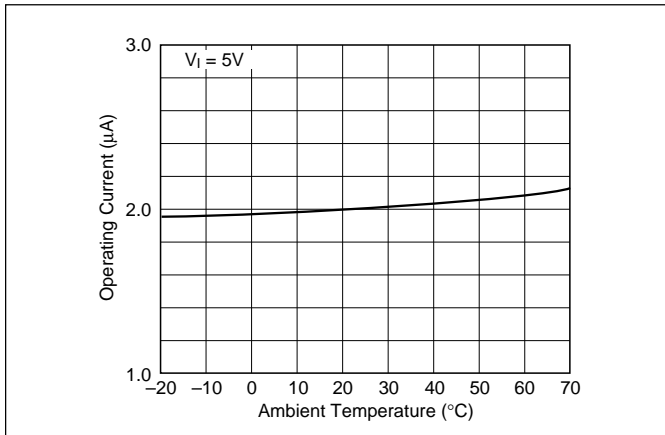

Operating current vs Input voltage

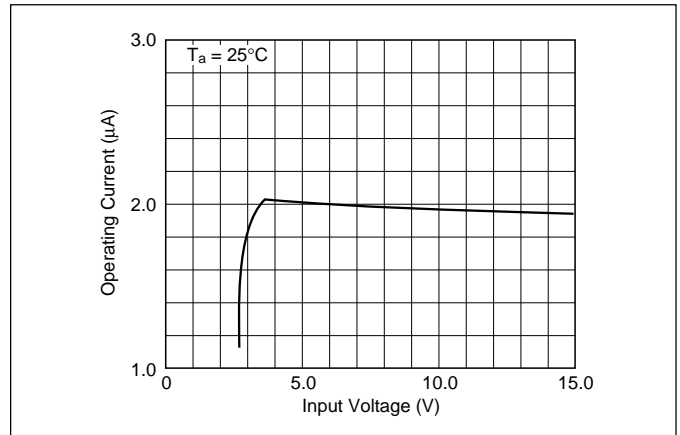

Output voltage vs. ambient temperature

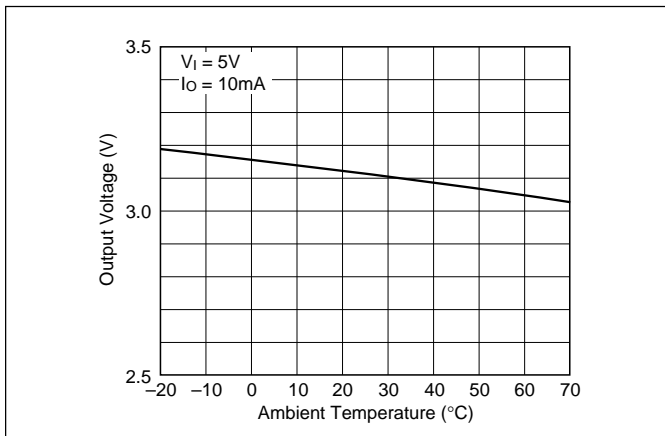

Output voltage drift vs. ambient temperature

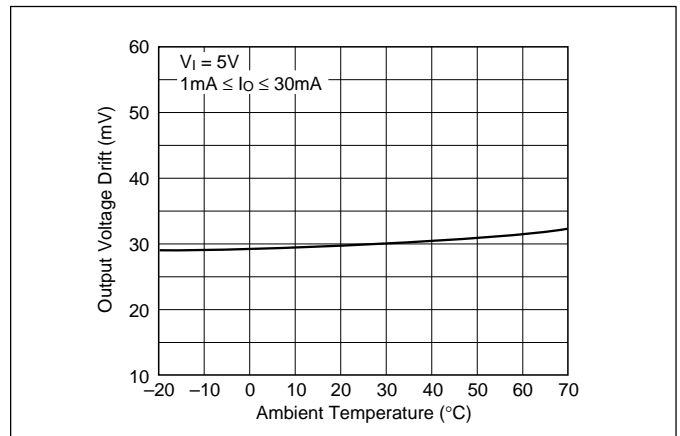

September 1993

■ TYPICAL PERFORMANCE CHARACTERISTICS (CONT.)

● SCI7710YMA

Output voltage vs. input voltage

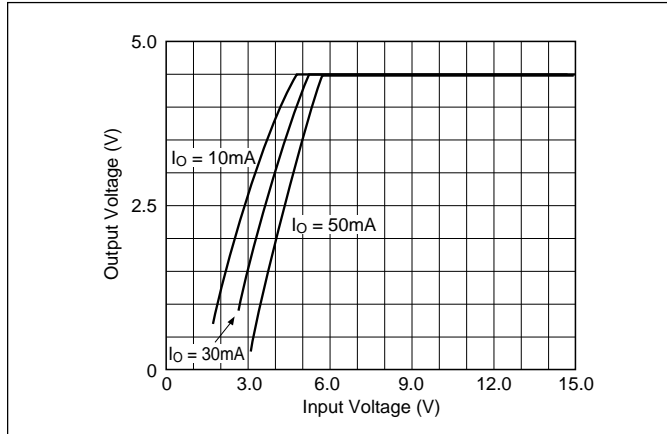

Input/output voltage differential vs. ambient temperature

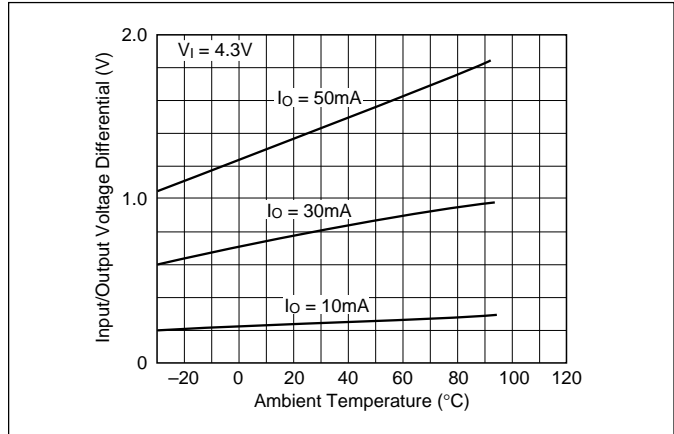

Operating current vs. ambient temperature

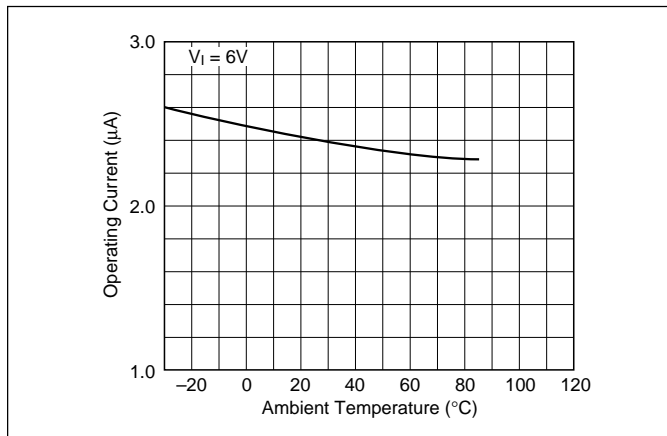

Operating current vs Input voltage

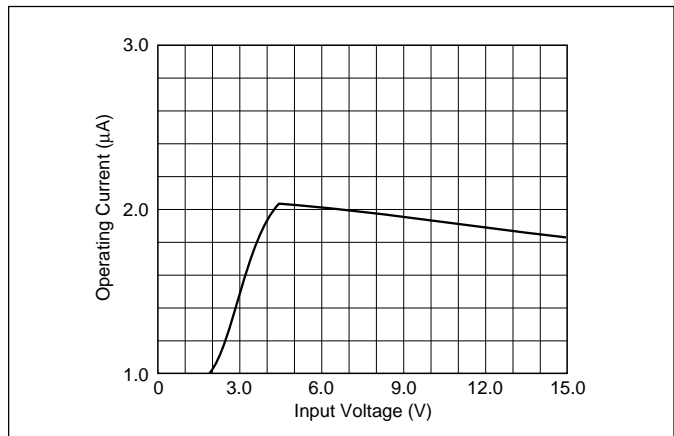

Output voltage vs. ambient temperature

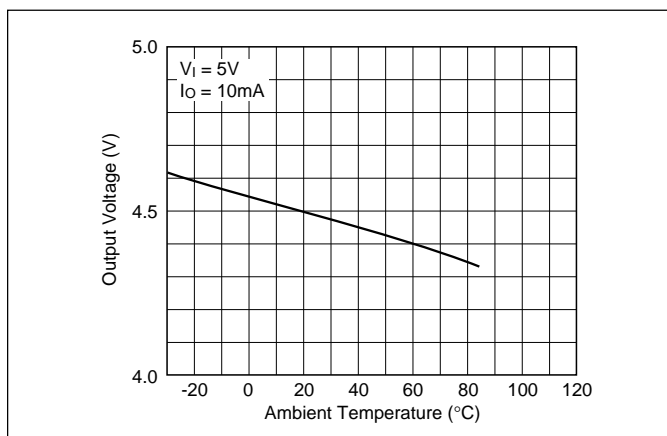

Output voltage drift vs. ambient temperature

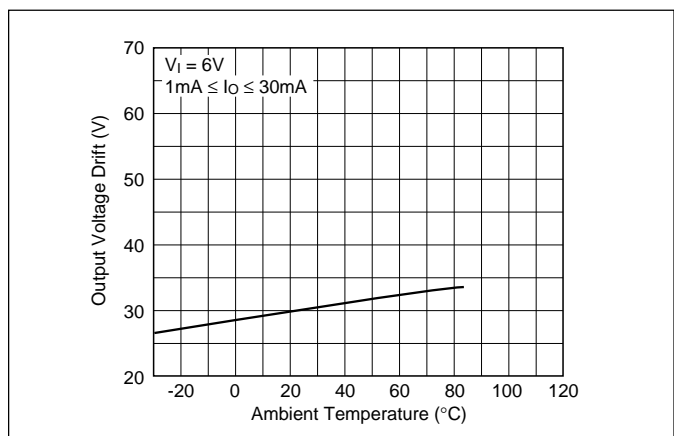

■ TYPICAL PERFORMANCE CHARACTERISTICS (CONT.)

● SCI7710YKA

Output voltage vs. input voltage

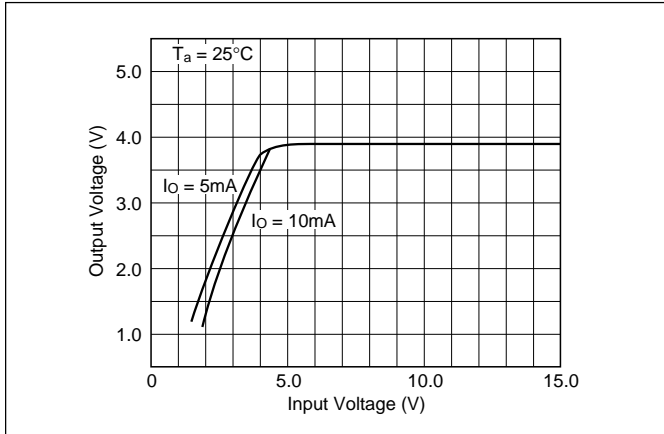

Input/output voltage differential vs. ambient temperature

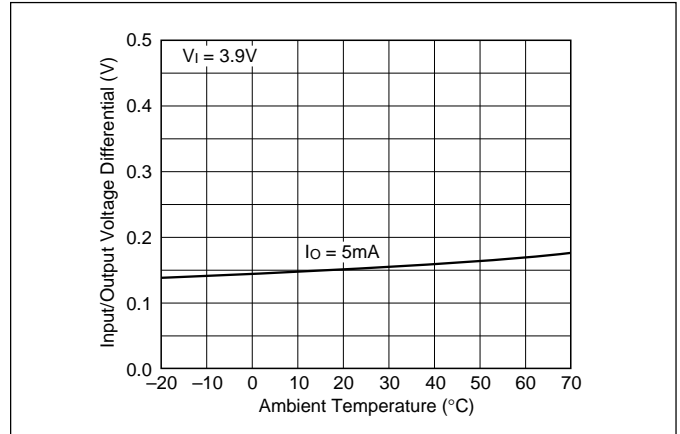

Operating current vs. ambient temperature

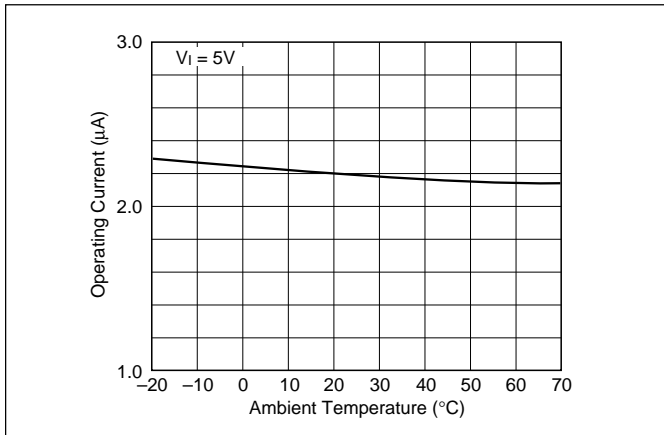

Operating current vs Input voltage

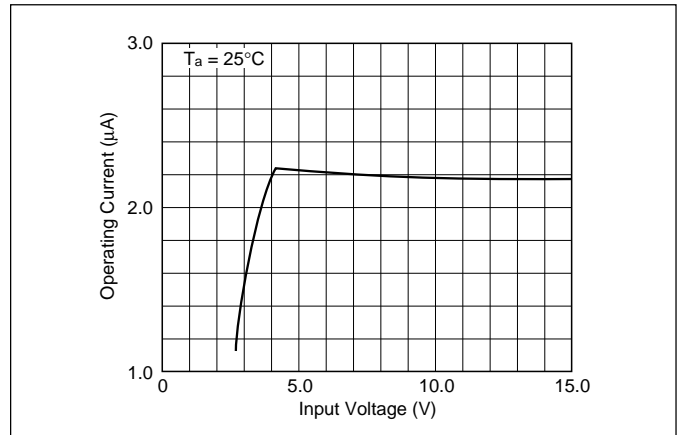

Output voltage vs. ambient temperature

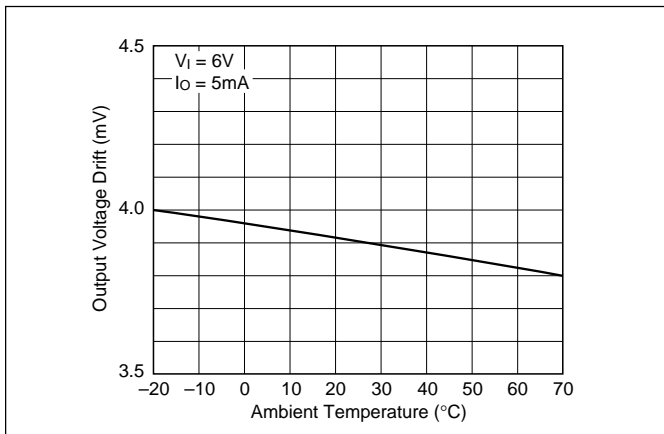

Output voltage drift vs. ambient temperature

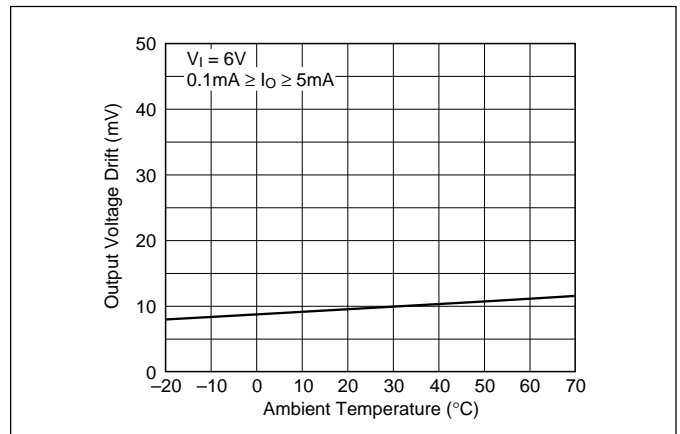

September 1993

■ TYPICAL PERFORMANCE CHARACTERISTICS (CONT.)

● SCI7710YBA

Output voltage vs. input voltage

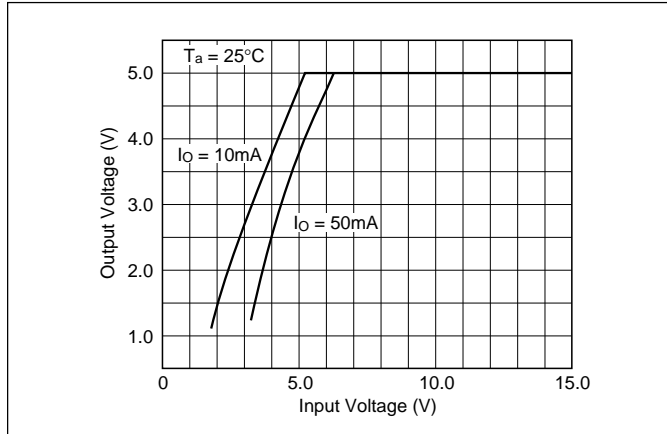

Input/output voltage differential vs. ambient temperature

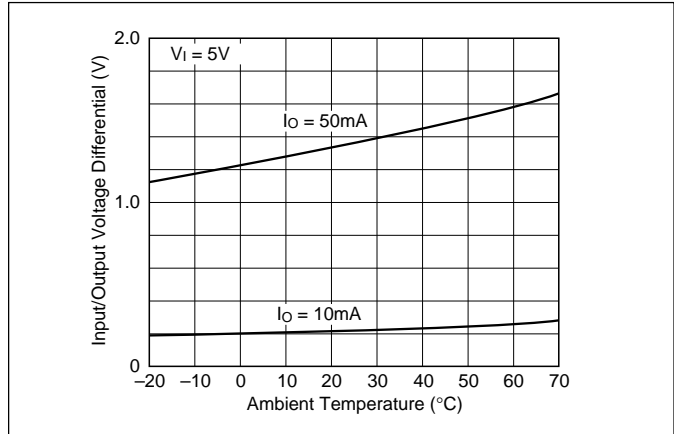

Operating current vs. ambient temperature

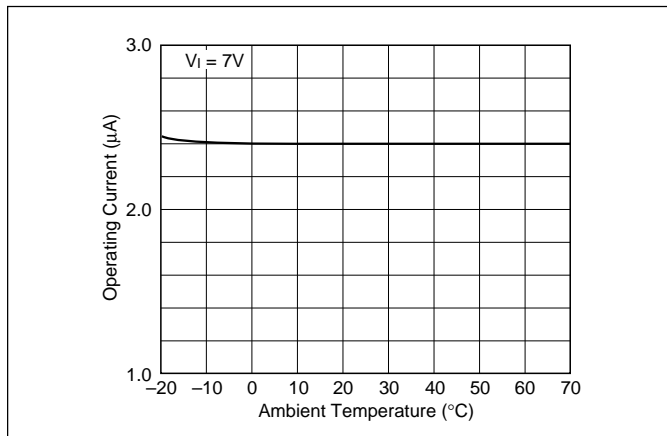

Operating current vs Input voltage

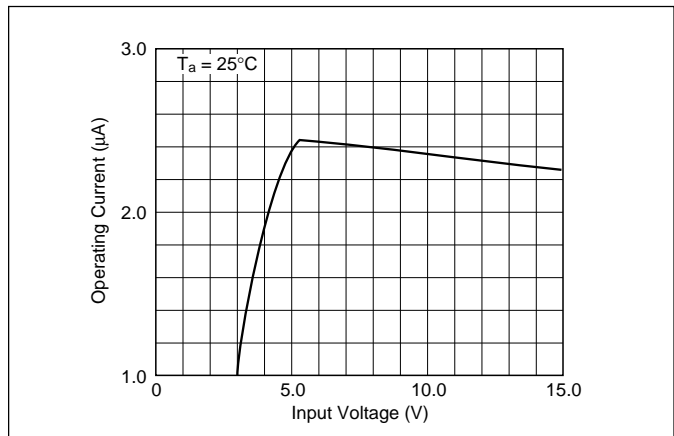

Output voltage vs. ambient temperature

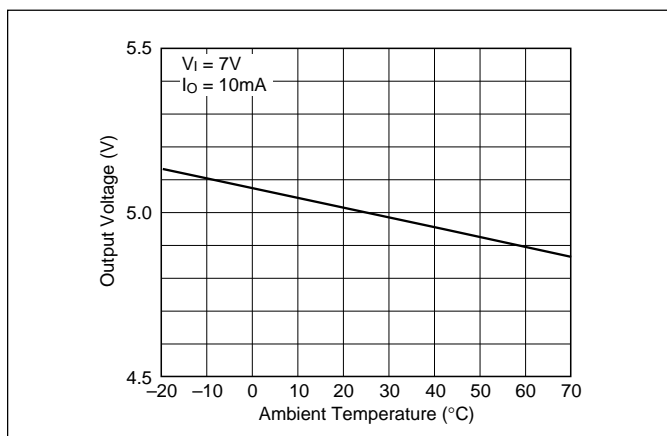

Output voltage drift vs. ambient temperature

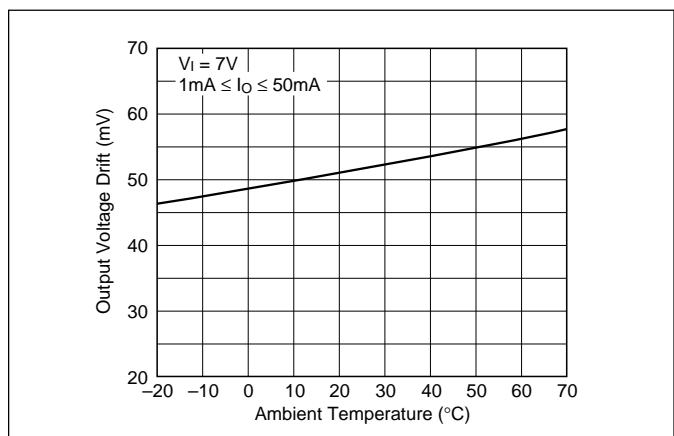

■ PACKAGE MARKING

The markings on SCI7710Y/11Y series device packages use the following abbreviations.

Parameter	Code	Description
Output voltage code	H	1.5V
	G	1.8V
	F	2.2V
	L	2.6V
	D	3.0V
	C	3.2V
	K	3.9V
	M	4.5V
	B	5.0V
Voltage regulator code	P	Positive
	N	Negative

■ MARKING LOCATIONS

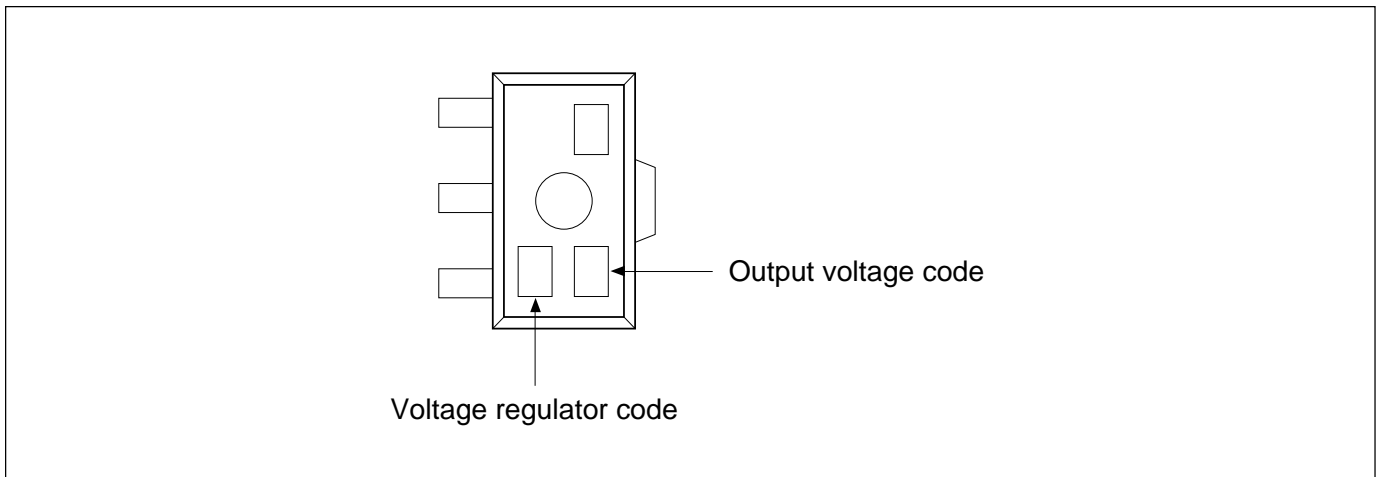

September 1993

FUNCTIONAL DESCRIPTION

Basic Operation

The SCI7710Y series uses a 3-pin series regulator feedback loop. An operational amplifier compares V_{REG} from the voltage divider formed by R_1 and R_2 , with V_{REF} . The amplifier output adjusts the output transistor gate bias to equalize the voltages and compensate for fluctuations in V_1 .

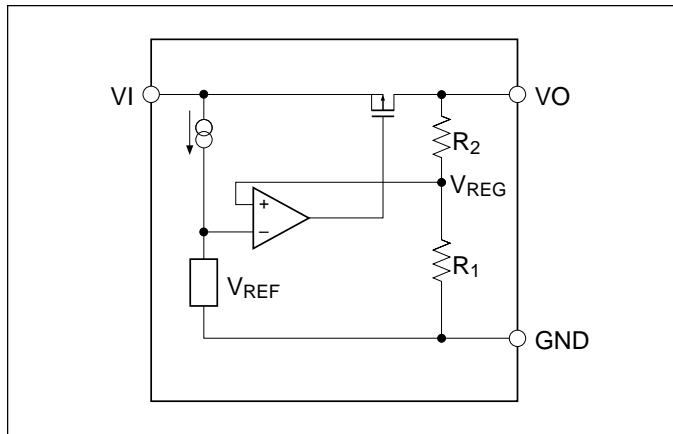

The following equation shows the relationship between V_O and V_{REF} .

$$V_O = \frac{R_1 + R_2}{R_1} V_{REF}$$

Internal Circuits-Reference voltage generator

The offset structure, used in all three transistors, results in a high breakdown voltage that ensures a stable reference voltage output over a wide range of input voltages.

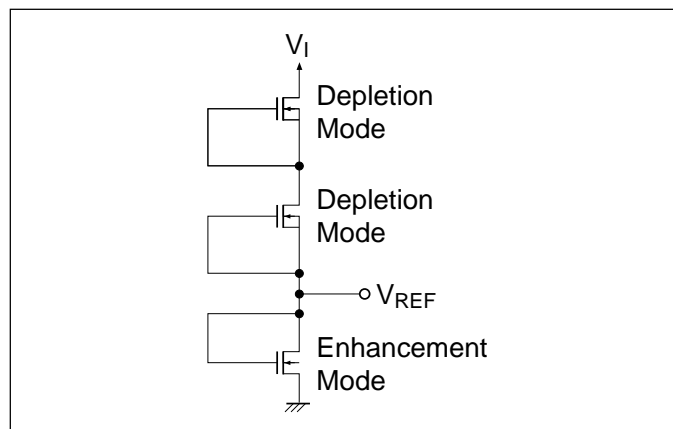

Differential Amplifier

The built-in differential amplifier generates a potential at point X that adjusts the gate bias of the output transistor if there is any difference between V_{REF} and V_{REG} .

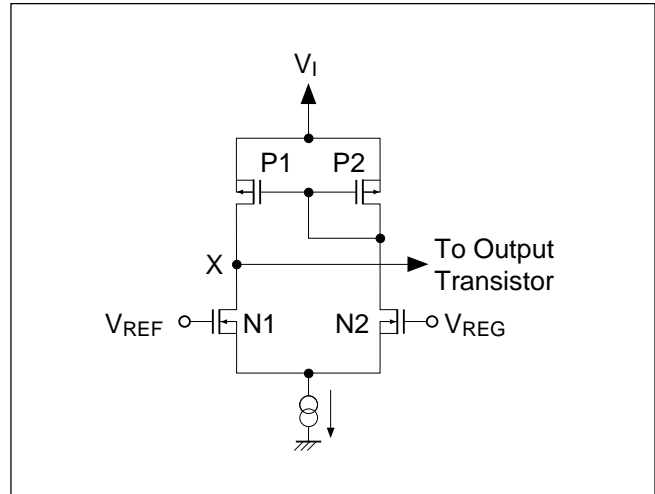

Output transistor

The output side of the p-channel MOS transistors in the output transistor circuit is connected to the voltage divider resistors in the feedback loop.

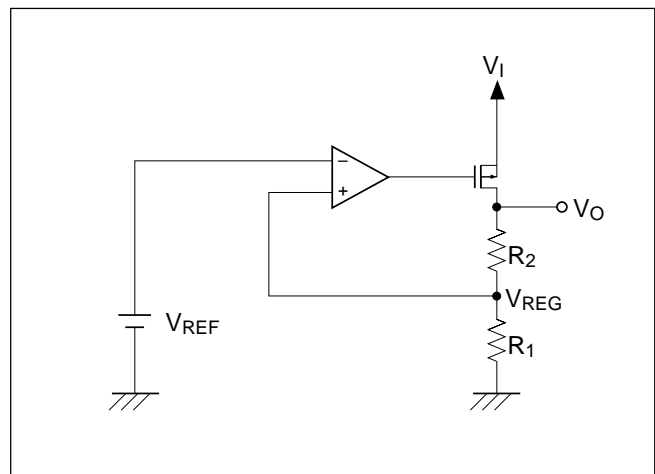

■ **TYPICAL APPLICATIONS**

● **Current Booster**

At the cost of a small increase in current consumption, the voltage is regulated while maintaining high current output.

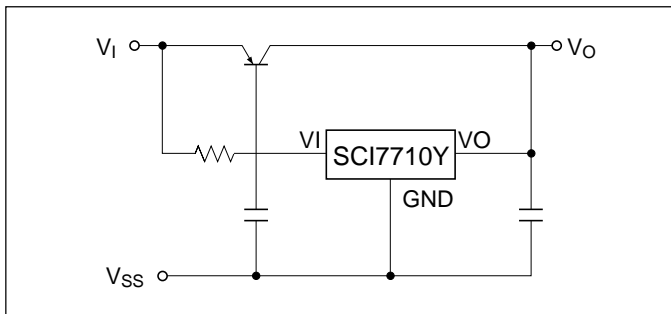

● **External Voltage Converter**

The following circuit raises the output voltage of a SCI7710Y series IC.

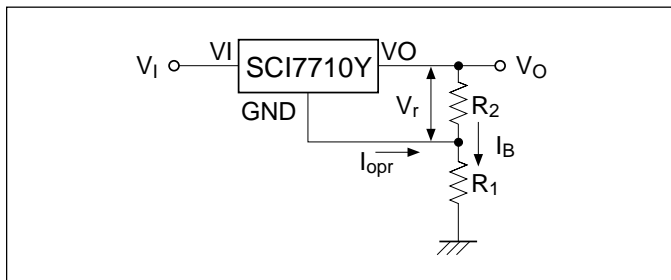

The following equation shows the relationship between the old and new voltages.

$$V_O = \frac{R_1 + R_2}{R_2} V_R$$

Note that the application must supply a bias current, I_B , high enough to offset the increase in voltage across R_1 due to I_{opr} . An alternative circuit for raising the output voltage is shown in the following figure.

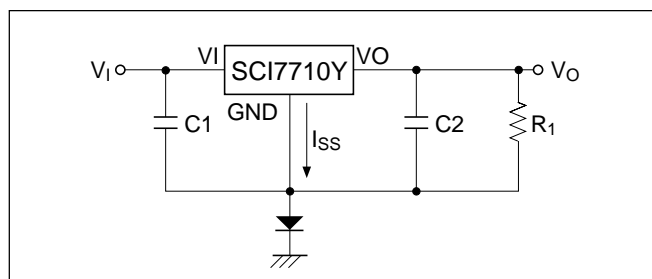

This configuration, however, introduces two design problems.

1. It reduces the output voltage by V_F , the forward voltage drop across the diode.
2. It is sensitive to fluctuations in V_F due to differences in diodes, operating temperatures and I_{SS} .

R_1 helps reduce the effect of I_{SS} on V_F . It is also required when I_{SS} is lower than the diode bias current. For certain input voltages, a Zener diode with a reverse polarity can be used.

● **Higher Input Voltages**

A preliminary regulator circuit is required to bring the input voltage within the SCI7710Y series rated range.

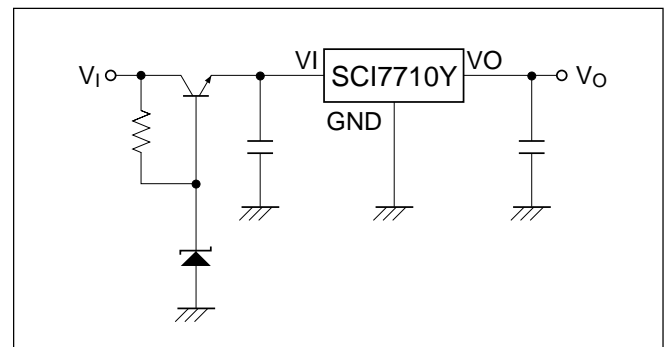

● **Switching output**

SCI7710Y series devices are designed for continuous operation. An external switching circuit allows the regulated output to be switched ON and OFF.

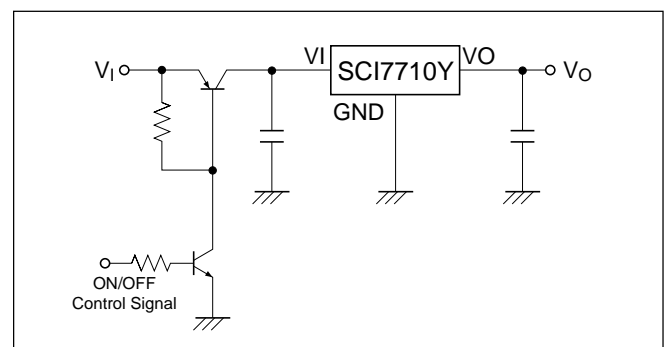

September 1993

West Coast S-MOS Systems, Inc. 150 River Oaks Parkway San Jose, CA 95134 Tel. (408) 922-0200 Fax (408) 922-0238	North East and North Central S-MOS Systems, Inc. 301 Edgewater Place, Suite 120 Wakefield, MA 01880 Tel. (617) 246-3600 Fax (617) 246-5443	South East and South Central S-MOS Systems, Inc. 4300 Six Forks Road, Suite 430 Raleigh, NC 27609 Tel. (919) 781-7667 Fax (919) 781-6778	More info... World Wide Web: http://www.smos.com/
---	--	--	---

S-MOS assumes no responsibility or liability for (1) any errors or inaccuracies contained in the information herein and (2) the use of the information or a portion thereof in any application, including any claim for (a) copyright or patent infringement or (b) direct, indirect, special or consequential damages. There are no warranties extended or granted by this document. The information herein is subject to change without notice from S-MOS.