

Metal Oxide Varistor Data Sheet

Features

- TMOV integrated thermal protection device
- High peak surge current rating up to 6KA
- Designed to facilitate compliance to UL1449 for TVSS products
- Wide operating voltage (V_{1mA}) range from 82V to 1200V
- Rated current: 5A
- Rated Functioning Temperature: 136(°C)
- Fast responding to transient over-voltage and limited current
- Large absorbing transient energy capability
- Low clamping ratio and no follow-on current
- Three-lead version available for indication purposes
- Meets MSL level 1, per J-STD-020
- Operating Temperature: -40°C ~ +85°C
- Storage Temperature: -40°C ~ +85°C
- Safety certification: UL: E327997

Applications

- AC power line or AC/DC supplies
- Transistor, diode, IC, thyristor or triac semiconductor protection
- Surge protection in consumer electronics
- Surge protection in industrial electronics
- Surge protection in electronic home appliances, gas and petroleum appliances
- Relay and electromagnetic valve surge absorption
- AC panel protection Modules

Part number code

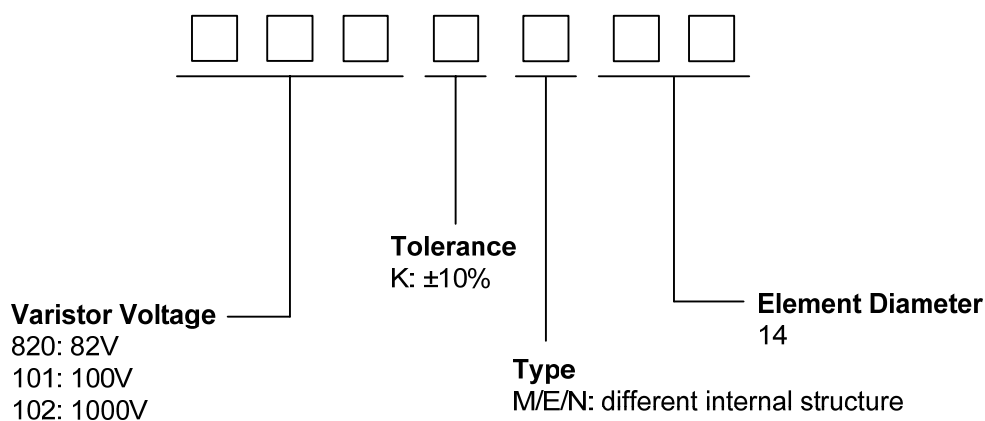

Lead configurations and application examples

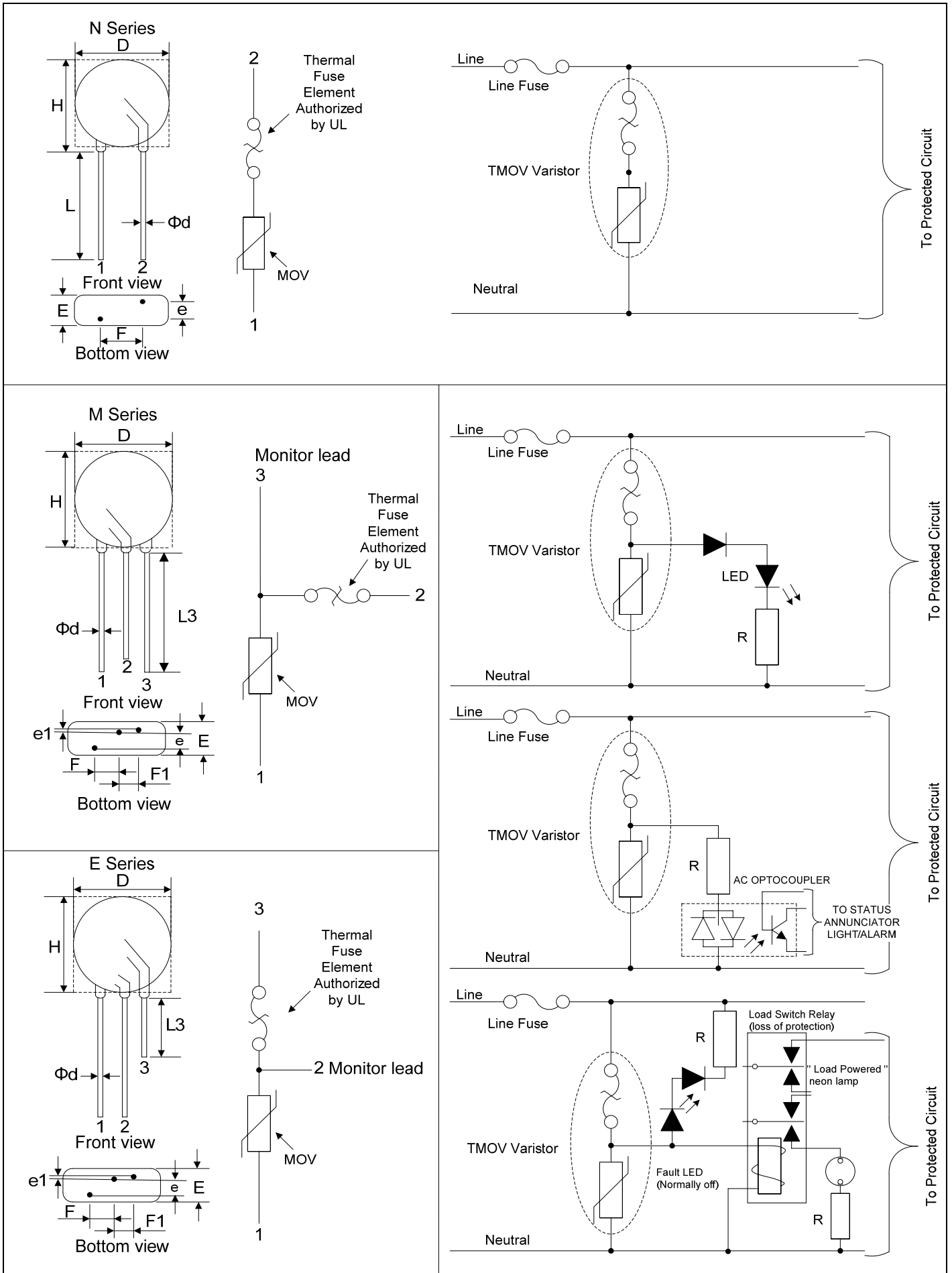

Dimensions

Symbol		BK'S M / E / N Varistor		
		14M	14E	14N
		Unit: mm		
D (max.)		19.0	19.0	19.0
H (max.)		21.0	21.0	21.0
F (±1.0)		7.5	7.5	7.5
F1 (±1.0)		5.0	5.0	-
e (max.)	820K~121K	2.8	2.8	2.8
	151K~391K	3.8	3.8	3.8
	431K~621K	5.5	5.5	5.5
	681K~911K	7.8	7.8	7.8
	102K~122K	10.0	10.0	10.0
e1	820K~121K	1.3±0.8	1.3±0.8	-
	151K~391K			
	431K~621K			
	681K~911K			
	102K~122K			
E (max.)	820K~121K	8.8	8.8	8.8
	151K~391K	9.8	9.8	9.8
	431K~621K	11.5	11.5	11.5
	681K~911K	13.8	13.8	13.8
	102K~122K	16.0	16.0	16.0
L (min.)		20.0	20.0	20.0
L3 (min.)		10.0	10.0	-
Φd		0.8		

Electrical characteristics

Part Number	Maximum Allowable Voltage		Varistor Voltage	Maximum Clamping Voltage		Maximum Peak Current (8/20 μ s)		Maximum Energy (Joule)		Rated Power	Typical Capacitance (Reference)
	V _{AC} (V)	V _{DC} (V)	V _{1mA} (V)	I _P (A)	V _C (V)	1 time	2 times	10/1000 μ s	2ms	(W)	@1KHz (pf)
						(A)					
820KM(E,N)14	50	65	82(74~90)	50	135	4500	2500	27	22	0.6	2400
101KM(E,N)14	60	85	100(90~110)	50	165	4500	2500	33	28	0.6	2000
121KM(E,N)14	75	100	120(108~132)	50	200	4500	2500	40	32	0.6	1700
151KM(E,N)14	95	125	150(135~165)	50	250	6000	4500	50	35	0.6	1300
181KM(E,N)14	115	150	180(162~198)	50	300	6000	4500	58	40	0.6	1100
201KM(E,N)14	130	170	200(185~225)	50	340	6000	4500	70	50	0.6	1000
221KM(E,N)14	140	180	220(198~242)	50	365	6000	4500	78	55	0.6	900
241KM(E,N)14	150	200	240(216~264)	50	395	6000	4500	85	60	0.6	830
271KM(E,N)14	175	225	270(243~297)	50	455	6000	4500	100	70	0.6	740
301KM(E,N)14	190	250	300(270~330)	50	500	6000	4500	107	75	0.6	670
331KM(E,N)14	210	275	330(297~363)	50	550	6000	4500	115	80	0.6	610
361KM(E,N)14	230	300	360(324~396)	50	595	6000	4500	125	90	0.6	560
391KM(E,N)14	250	320	390(351~429)	50	650	6000	4500	140	100	0.6	510
431KM(E,N)14	275	350	430(387~473)	50	710	6000	4500	155	110	0.6	460
471KM(E,N)14	300	385	470(423~517)	50	775	6000	4500	175	125	0.6	430
511KM(E,N)14	320	415	510(459~561)	50	845	6000	4500	190	136	0.6	390
561KM(E,N)14	350	460	560(504~616)	50	920	6000	4500	200	140	0.6	360
621KM(E,N)14	385	505	620(558~682)	50	1025	6000	4500	210	150	0.6	320
681KM(E,N)14	420	560	680(612~748)	50	1120	6000	4500	220	155	0.6	290
751KM(E,N)14	460	615	750(675~825)	50	1240	6000	4500	225	160	0.6	270
781KM(E,N)14	485	640	780(702~858)	50	1290	6000	4500	240	165	0.6	260
821KM(E,N)14	510	670	820(738~902)	50	1355	6000	4500	245	170	0.6	240
911KM(E,N)14	550	745	910(819~1001)	50	1500	6000	4500	255	180	0.6	220
102KM(E,N)14	625	825	1000(900~1100)	50	1650	6000	4500	280	190	0.6	200
112KM(E,N)14	680	895	1100(990~1210)	50	1815	6000	4500	310	205	0.6	180
122KM(E,N)14	750	990	1200(1080~1320)	50	1980	6000	4500	338	215	0.6	150

Mechanical Characteristics

Items	Test conditions / Methods	Specifications								
Tensile Strength of Terminals	Gradually applying the force specified and keeping the unit fixed for 10±1 sec. <table border="1" style="margin-left: auto; margin-right: auto;"> <thead> <tr> <th>Terminal diameter (mm)</th> <th>Force (kg)</th> </tr> </thead> <tbody> <tr> <td>0.5<d≤0.8</td> <td>1.0</td> </tr> <tr> <td>0.8<d≤1.25</td> <td>2.0</td> </tr> <tr> <td>1.25<d</td> <td>4.0</td> </tr> </tbody> </table>	Terminal diameter (mm)	Force (kg)	0.5<d≤0.8	1.0	0.8<d≤1.25	2.0	1.25<d	4.0	No visible damage ΔV _{1mA} /V _{1mA} ≤5%
Terminal diameter (mm)	Force (kg)									
0.5<d≤0.8	1.0									
0.8<d≤1.25	2.0									
1.25<d	4.0									
Bending Strength of Terminals	Hold specimen and apply the force specified below to each lead. Bend the specimen to 90°, then return to the original position. Repeat the procedure in the opposite direction. <table border="1" style="margin-left: auto; margin-right: auto;"> <thead> <tr> <th>Terminal diameter (mm)</th> <th>Force (kg)</th> </tr> </thead> <tbody> <tr> <td>0.5<d≤0.8</td> <td>0.5</td> </tr> <tr> <td>0.8<d≤1.25</td> <td>1.0</td> </tr> <tr> <td>1.25<d</td> <td>2.0</td> </tr> </tbody> </table>	Terminal diameter (mm)	Force (kg)	0.5<d≤0.8	0.5	0.8<d≤1.25	1.0	1.25<d	2.0	No visible damage ΔV _{1mA} /V _{1mA} ≤5%
Terminal diameter (mm)	Force (kg)									
0.5<d≤0.8	0.5									
0.8<d≤1.25	1.0									
1.25<d	2.0									
Vibration	Frequency range: 10~55 Hz Amplitude: 0.75mm or 98m/s ² Direction: 3 mutually perpendicular directions, 2hrs each.	No visible damage ΔV _{1mA} /V _{1mA} ≤5%								
Solder ability	Solder Temp: 245±5°C Dipping Time: 2±0.5 sec	At least 95% of terminal electrode is covered by new solder								
Resistance to Soldering Heat	Solder Temp: 260±5°C Dipping Time: ≤5 sec	No visible damage ΔV _{1mA} /V _{1mA} ≤10%								

Reliability

Items	Test conditions / Methods	Specifications															
High Temperature Storage	Ambient Temp: 85±2°C Duration: 1000hrs	ΔV _{1mA} /V _{1mA} ≤5%															
Low Temperature Storage	Ambient Temp: -40±2°C Duration: 1000hrs	ΔV _{1mA} /V _{1mA} ≤5%															
Humidity	Ambient Temp: 40±2°C, 90~95% R.H. Duration: 1000hrs	ΔV _{1mA} /V _{1mA} ≤5%															
Temperature Cycle	The conditions shown below shall be repeated 5 cycles <table border="1" style="margin-left: auto; margin-right: auto;"> <thead> <tr> <th>Step</th> <th>Temperature (°C)</th> <th>Period (minutes)</th> </tr> </thead> <tbody> <tr> <td>1</td> <td>-40±3</td> <td>30±3</td> </tr> <tr> <td>2</td> <td>Room temperature</td> <td>15±3</td> </tr> <tr> <td>3</td> <td>85±3</td> <td>30±3</td> </tr> <tr> <td>4</td> <td>Room temperature</td> <td>15±3</td> </tr> </tbody> </table>	Step	Temperature (°C)	Period (minutes)	1	-40±3	30±3	2	Room temperature	15±3	3	85±3	30±3	4	Room temperature	15±3	No visible damage ΔV _{1mA} /V _{1mA} ≤5%
Step	Temperature (°C)	Period (minutes)															
1	-40±3	30±3															
2	Room temperature	15±3															
3	85±3	30±3															
4	Room temperature	15±3															
High Temperature Load	Ambient Temp: 85±2°C Duration: 1000hrs Load: Max. Allowable Voltage In AC eara.	ΔV _{1mA} /V _{1mA} ≤10%															
Damp Heat Load	Ambient Temp: 40±2°C, 90~95% R.H. Duration: 1000hrs Load: Max. Allowable Voltage	No visible damage ΔV _{1mA} /V _{1mA} ≤10%															
Voltage Proof	Metal balls method, 2500Vac 1 min.	No visible damage															

Maximum Leakage Current and Maximum Clamping Voltage Curve

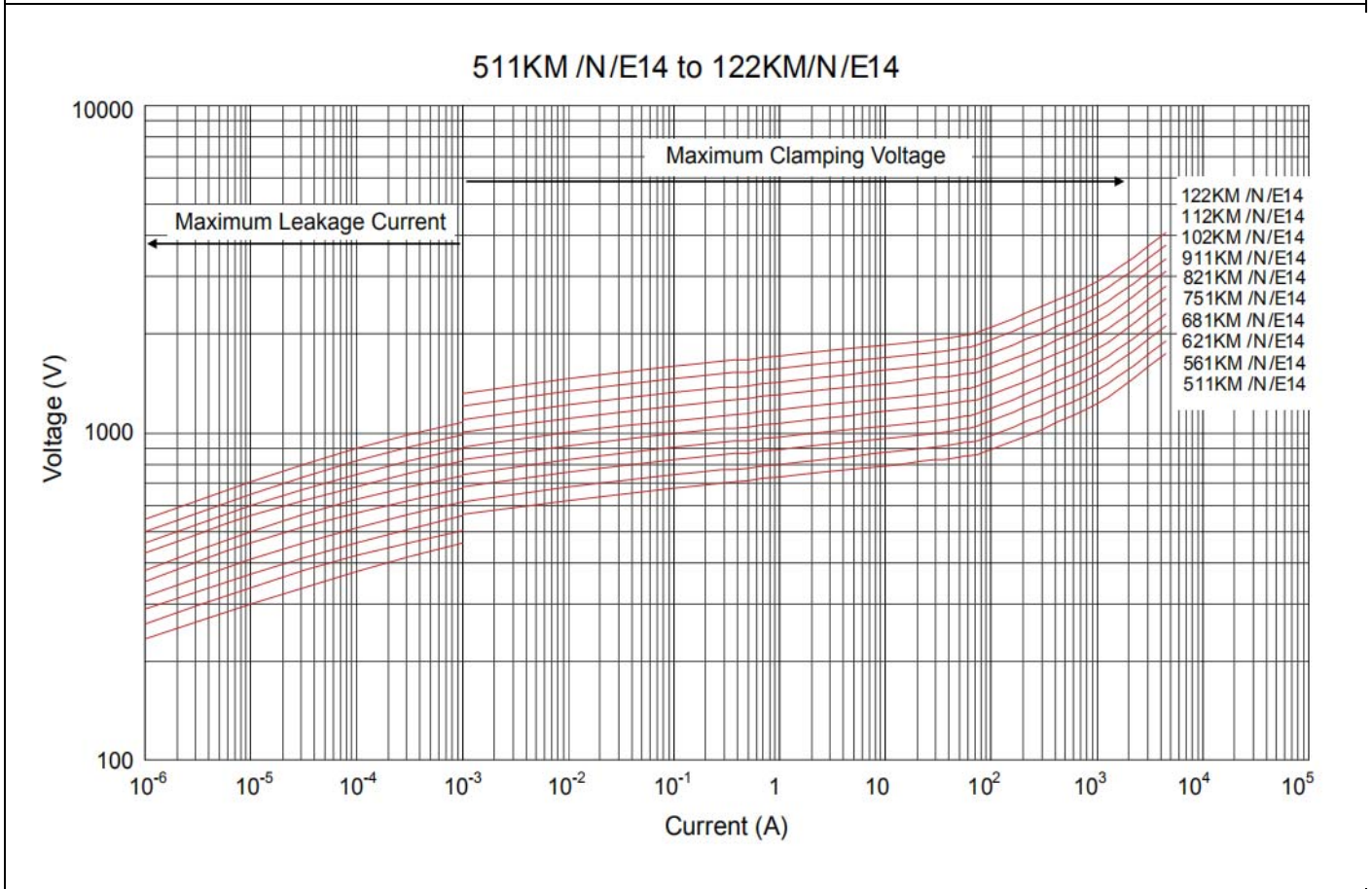
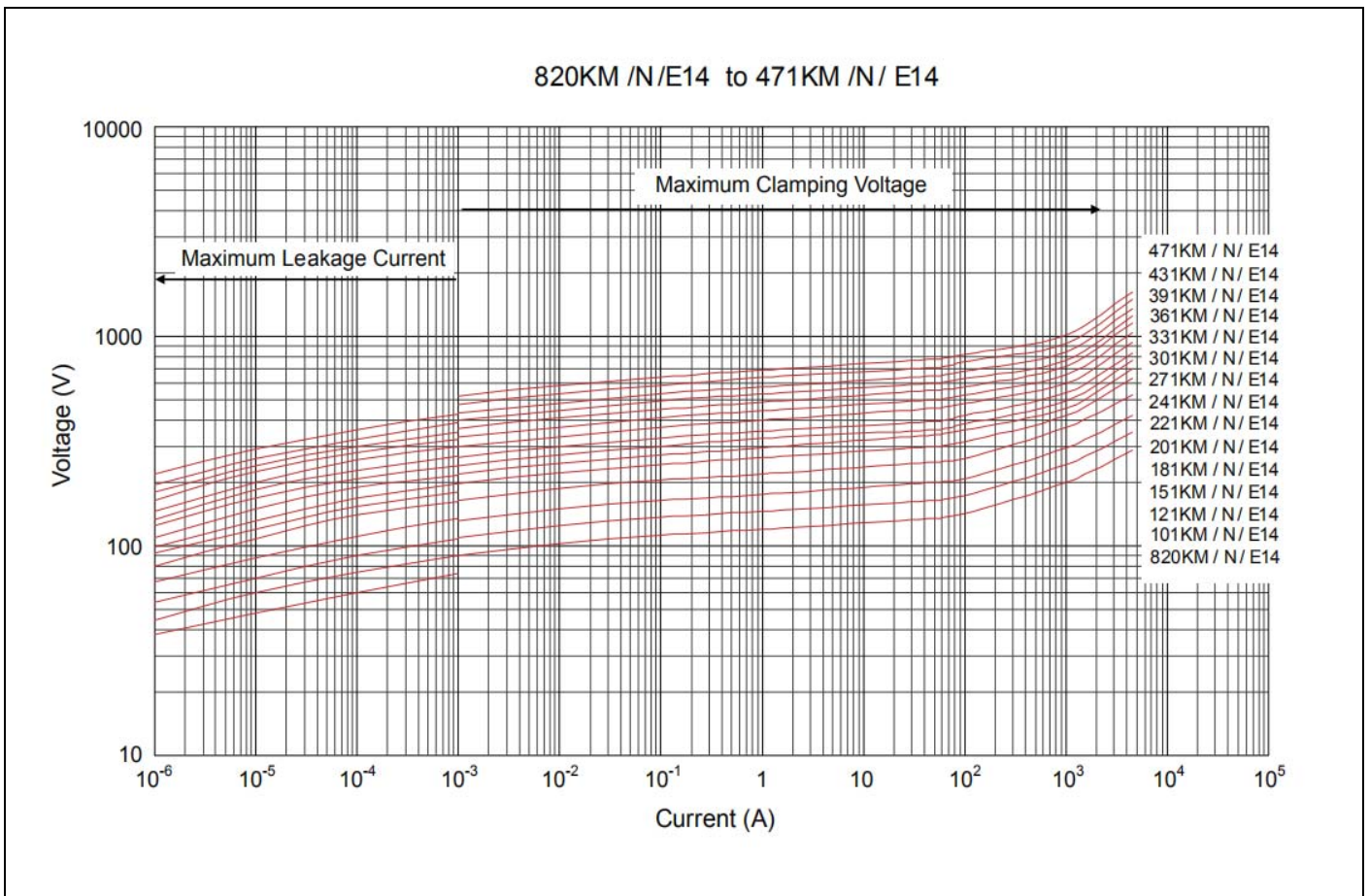

Maximum Surge Current Derating Curve

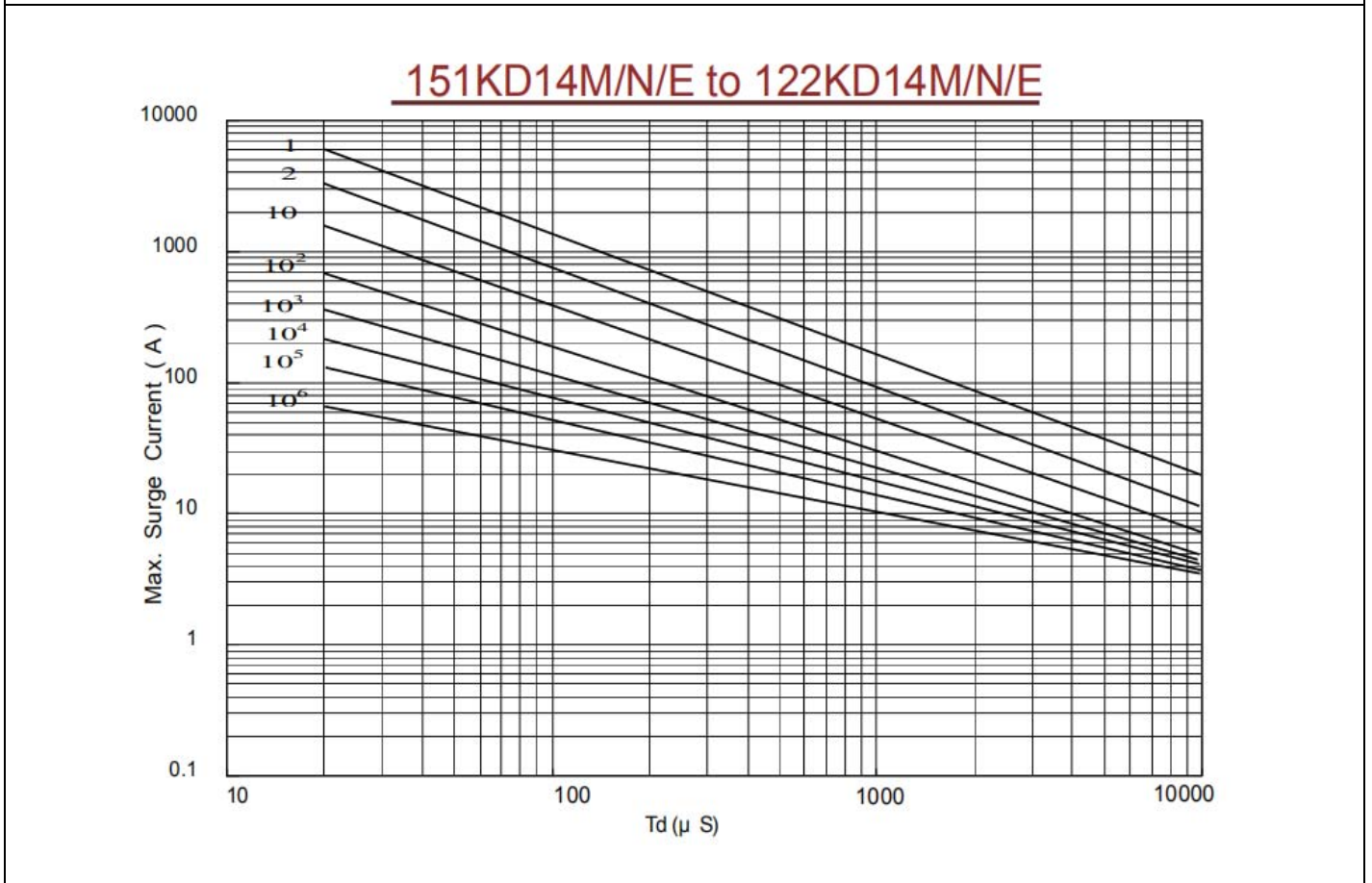
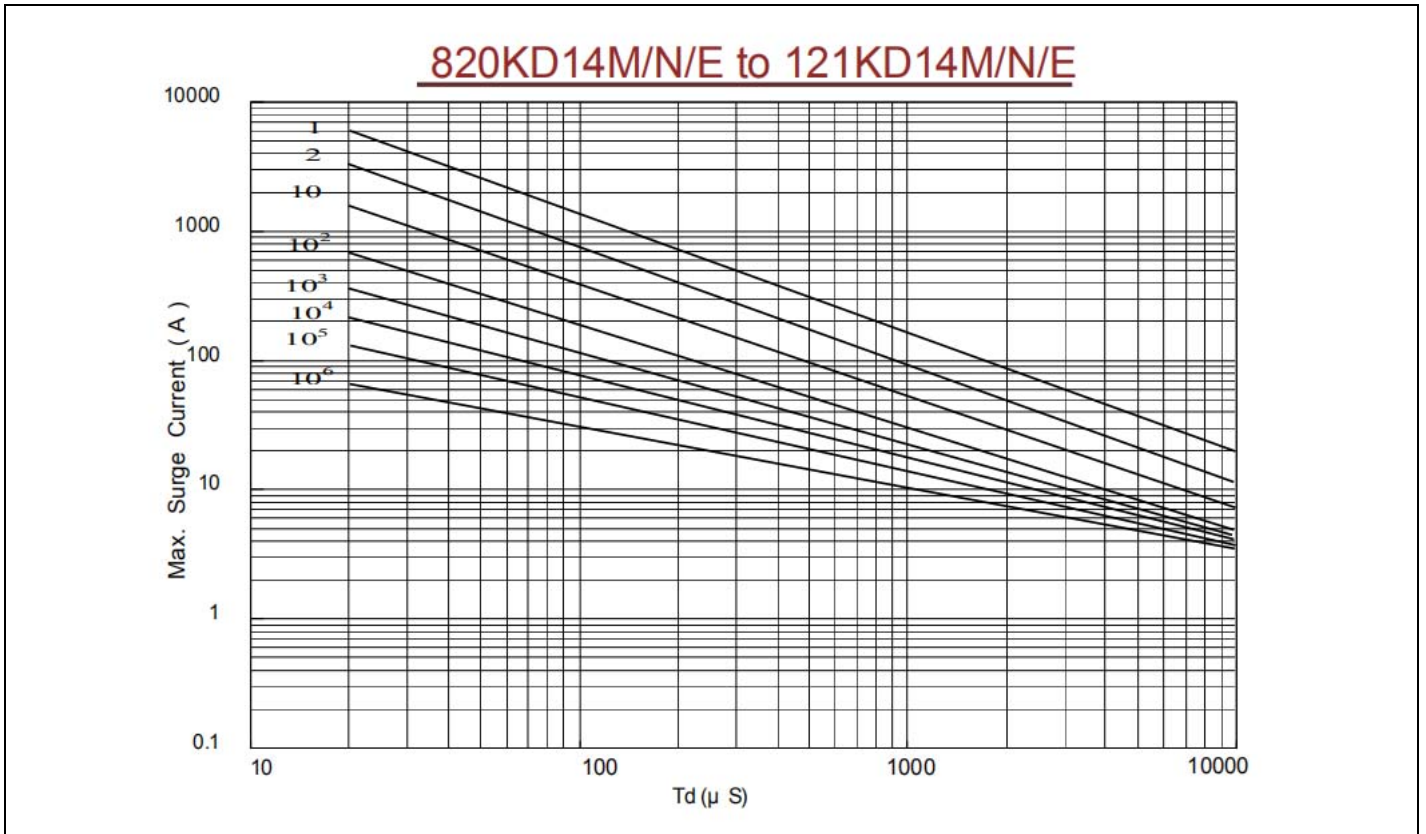

Soldering Recommendation

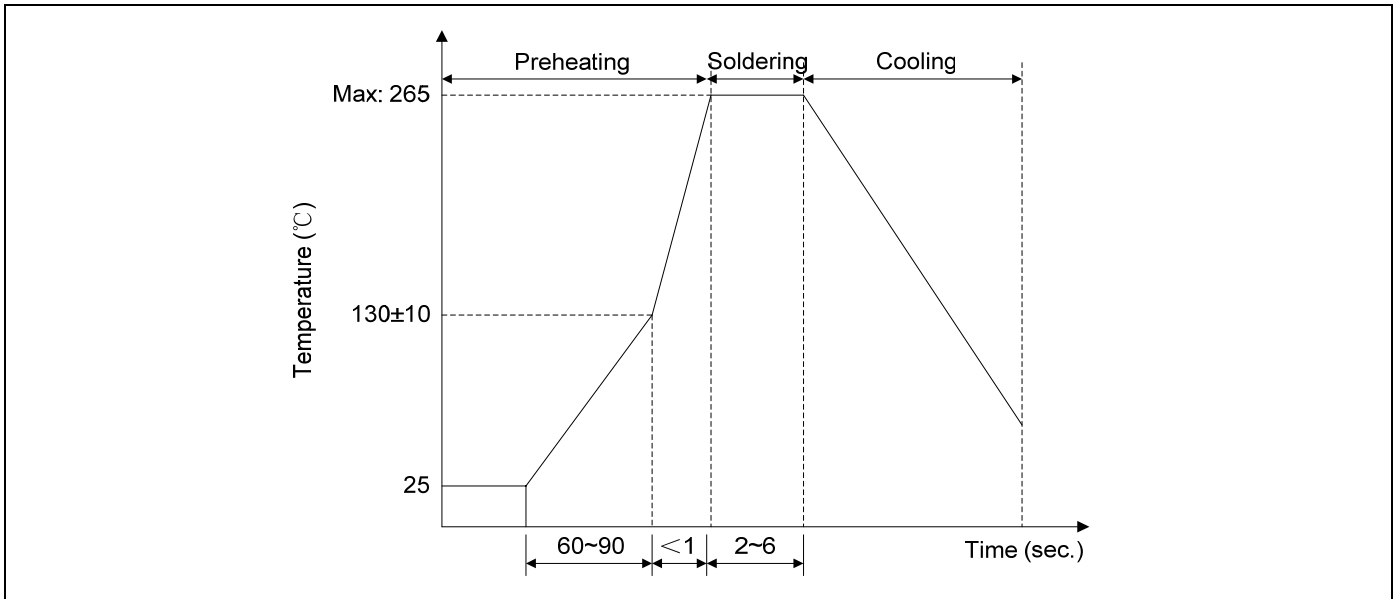

Marking code

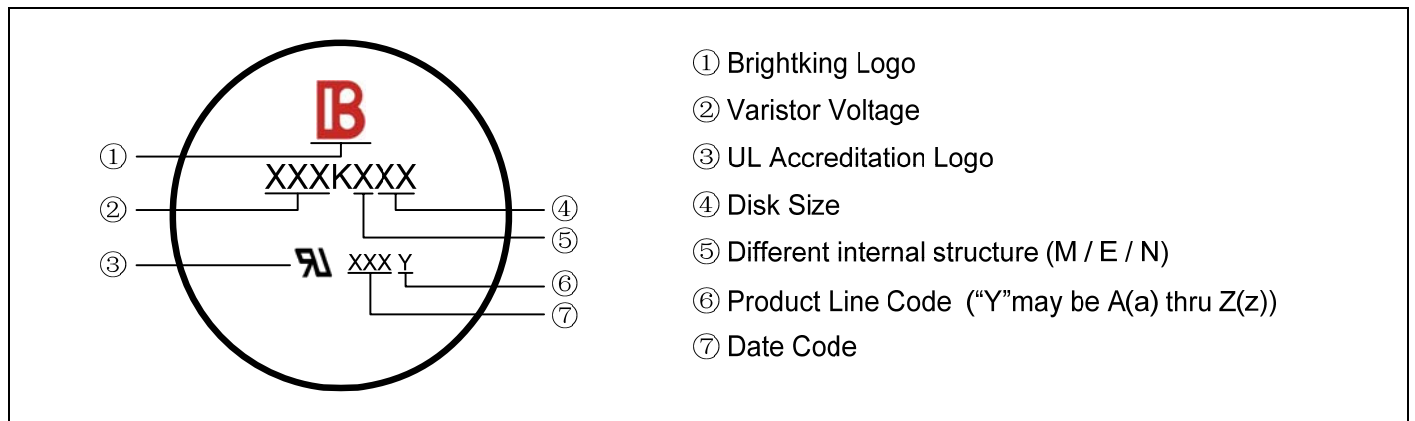

Quantity

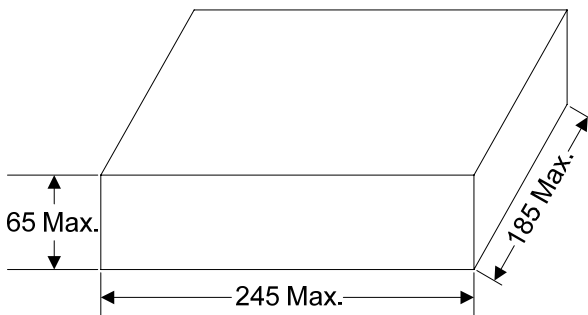
Packaging Dimensions (Unit: mm)	Quantity
<p>Bulk</p> 	<p>200pcs/bag 2bags/box</p>