

CUSTOMER: Ropla Elektronik Sp. z o.o.
DATE: January 12,2024

SPECIFICATION

DESCRIPTION: Aluminium Electrolytic Capacitors

AISHI P/N: ENL2WM153VM0B0ZC

SERIES: NL

ITEM: 450 V 15000 μ F (Φ 91 × 220)

CUSTOMER P/N:

No.: CRS-LS-24011201

APPROVED BY

Please Return One Copy with Your Approval
承认后请寄回一份

PREPARED BY	CHECKED BY	APPROVED BY
		

CUSTOMER	Ropla Elektronik Sp. z o.o.	SERIES	NL	DATE	2024/01/12
-----------------	------------------------------------	---------------	-----------	-------------	-------------------

绝缘电压：2500VAC 1分钟
Insulation Voltage :2500VAC for 1min

M6端子扭力矩为5Nm
Robustness of M6's terminal:
tightening torque is 5 Nm

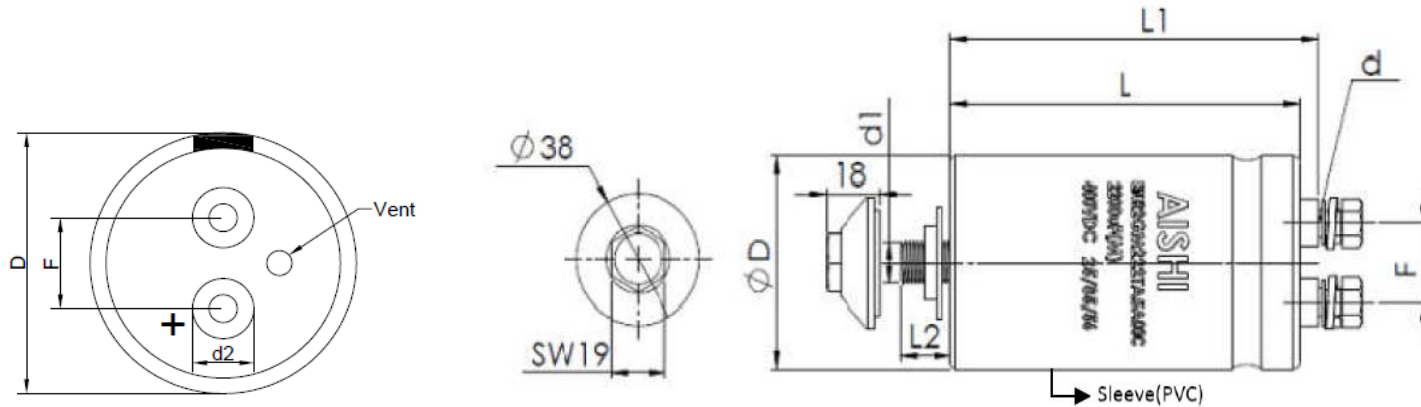

FIG-1

Dimensions (mm)

Aishi Part No.	D ⁺¹ ₋₂	F ^{+0.2} _{-0.4}	L ⁺³	L1 ^{±2}	L2 ⁺¹	d	d1	d2	电极端子螺丝		
ENL2WM153VM0B0ZC	91	31.7	220	225.5	16	M6	M12	17.4	M6*12		

TABLE-1

No.	Customer Part No.	Aishi Part No.	Capacitance (µF)	Capacitance Tolerance (%)	Rated Voltage (Vdc)	Surge Voltage (Vdc)	Operating Temp. Range (°C)	Tanδ Max at 20°C 120Hz	ESR Max at 20°C 120Hz (mΩ)	Leakage Current (µA)(5min.)	Max Ripple Current at 85°C 120Hz (Arms)	Endurance at 85°C (Hours)
1		ENL2WM153VM0B0ZC	15000	-20~+20	450	500	-40~+85	0.20	14.0	5000	28.0	12000

1 概述 SCOPE

本承认书规定了NL系列螺栓型铝电解电容器的技术规范，本技术规范条文解释权归本公司所有。

This specification covers NL series screw type aluminium electrolytic capacitors, AISHI reserves the right of final interpretation for this technical specification.

2 参考标准 APPLICABLE SPECIFICATION

本承认书参考IEC 60384-1、IEC 60384-4、GB/T 2693和GB/T 5993制定。

This specification consulted the institute of IEC 60384-1, IEC 60384-4, GB/T 2693 and GB/T 5993.

3 工作温度范围 OPERATING TEMPERATURE RANGE

工作温度范围是电容器在施加额定工作电压条件下，可以长期可靠工作的环境温度范围。

Operating temperature range is the range of ambient temperature at which the capacitor can be operated continuously at rated voltage.

-40°C~85°C 450V.DC

4 测试环境 CONDITION OF TEST

如果没有其他规定，标准的测试、检验环境条件如下所示：

环境温度：15°C~35°C

相对湿度：45%~75%

大气压力：86kPa~106kPa

如果对测试结果有异议，可以在以下条件测试：

环境温度：20±1°C

相对湿度：60%~67%

大气压力：86kPa~106kPa

Unless otherwise specified, the standard range of atmospheric conditions for making measurements and tests are as follows:

Ambient temperature : 15°C to 35°C

Relative humidity : 45% to 75%

Air pressure: 86kPa to 106kPa

If there may be doubt on the results, measurements shall be made within the following limits:

Ambient temperature : 20±1°C

Relative humidity : 60% to 67%

Air pressure : 86kPa to 106kPa

File Description	Approval Sheet				
Component P/N	NL	Version	01	Page	1
STANDARD MANUAL					

5 产品特性 PRODUCT CHARACTERISTICS

5.1 电气特性 Electrical Characteristics

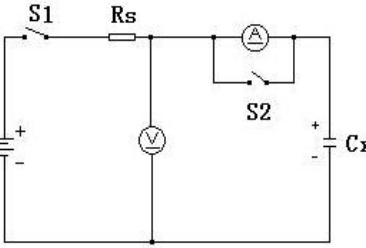
序号 No.	项目 Item	测试方法 Test method	性能 Performance
5.1.1	额定工作电压 Rated voltage	电压：直流电压值+交流电压峰值≤额定电压 Voltage: DC voltage + peak ripple voltage ≤ Rated voltage	见表1 See TABLE-1
5.1.2	电容量 Capacitance	测试频率：120Hz(±20%) 测试电路：串联等效 测试电压：0.5Vrms以下+1.5~ 2.0VDC Measuring frequency: 120Hz±20% Measuring circuit: Series equivalent circuit Measuring voltage: 0.5Vrms or less +1.5 to 2.0 VDC	容量偏差：见表1 Capacitance tolerance: See TABLE-1
5.1.3	损失角正切值 Dissipation factor	测试条件与5.1.2电容量测试相同。 Testing conditions are the same as 5.1.2 for capacitance.	DF见表1 DF: See TABLE-1
5.1.4	漏电流 Leakage current	<p>在电容器两端施加额定工作电压，并串联1000±100Ω电阻，在施加规定时间电压后，测量漏电流。</p> <p>测试电路如下图： The rated voltage shall be applied across the capacitor and its protective resistor shall be 1000±100Ω. The leakage current shall then be measured after a specified period of time. Test circuit:</p>  <p>Rs: Protective resistor(1000±100Ω) DC ammeter DC voltmeter S1: Switch S2: Protective switch for an ammeter</p>	<p>$I \leq 0.02CV$ 或 $5000\mu A$， 取较小值（5分钟后）</p> <p>$I \leq 0.02CV$ or $5000\mu A$ Whichever is smaller (after 5 min)</p> <p>I: 漏电流 (μA) C: 容量 (μF) V: 额定工作电压 (V) I: Leakage current(μA) C: Capacitance(μF) V: Rated voltage (V)</p>

File Description	Approval Sheet				
Component P/N	NL	Version	01	Page	2
STANDARD MANUAL					

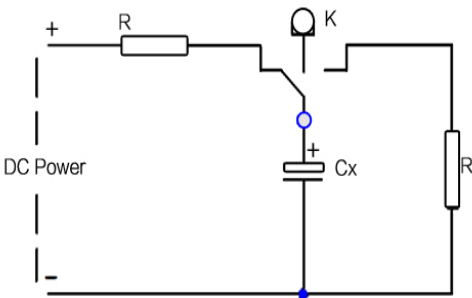
5.1.5	温度特性 Temperature characteristic	<table border="1"> <thead> <tr> <th>阶段 (Steps)</th> <th>温度 (Temp.)</th> <th>时间 (Time)</th> </tr> </thead> <tbody> <tr> <td>1</td> <td>20±2°C</td> <td>--</td> </tr> <tr> <td>2</td> <td>-25, -40 ⁺⁰/₋₃ °C</td> <td>2h</td> </tr> <tr> <td>3</td> <td>20±2°C</td> <td>15min.</td> </tr> <tr> <td>4</td> <td>85 ⁺³/₋₀ °C</td> <td>2h</td> </tr> </tbody> </table>	阶段 (Steps)	温度 (Temp.)	时间 (Time)	1	20±2°C	--	2	-25, -40 ⁺⁰ / ₋₃ °C	2h	3	20±2°C	15min.	4	85 ⁺³ / ₋₀ °C	2h	<p>阶段2: 容量与阶段1容量相比, 不大于表2要求; 阶段4: 容量变化应在初值的±20%范围内。 Step 2: capacitance value ratio to the value at step 1 shall be not more than the value given in TABLE-2. Step 4: capacitance change: Within ±20% of the initial value.</p>
		阶段 (Steps)	温度 (Temp.)	时间 (Time)														
1	20±2°C	--																
2	-25, -40 ⁺⁰ / ₋₃ °C	2h																
3	20±2°C	15min.																
4	85 ⁺³ / ₋₀ °C	2h																
<p>阶段1: 测量容量 (z , 20°C, 120Hz±20%) ; 阶段2: 电容器恒温贮存2小时, 在热平衡状态测量容量 (z , -25°C或-40°C, 120Hz±20%) ; 阶段4: 电容器恒温贮存2小时, 在热平衡状态测量容量。 Step 1: Capacitance shall be measured. (z ,20°C, 120Hz±20%); Step 2: After the capacitor being stored for 2 hours,capacitance shall be measured at thermal stability. (z ,-25°C or -40°C,120Hz±20%); Step 4:After the capacitor being stored for 2 hours, capacitance shall be measured at thermal stability.</p>																		
5.1.6	耐浪涌电压 Surge test	<p>施加表1所列浪涌电压, 充电30±5秒, 放电5.5±0.5分钟作为一个周期, 共进行1000次。 测试温度: 15°C-35°C 然后在标准大气条件下放置达到热稳定, 测试各参数 Application of DC surge Voltage stated at TABLE-1. 1000 times of charging for 30±5 sec., discharging with a period of 5.5±0.5 min.. Test temperature: 15°C-35°C And the capacitor shall be stored under standard atmospheric conditions to obtain thermal stability, after which measurements shall be made.</p>	<p>容量变化: 在初始值的±20%以内。 损耗角正切值不大于表1规定值的200%。 漏电流: 满足5.1.4要求。 Capacitance change: Within ±20% of the initial value Dissipation factor: Not more than 200% of the specified value in TABLE-1. Leakage current: To satisfy the requirement of No.5.1.4</p>															
		<p>Test circuit</p>  <p>Note: This requirement is only applicable to instantaneous over voltage which may be applied to terminals of capacitor, therefore, not applicable to such over voltages as often applied.</p>																

File Description	Approval Sheet				
Component P/N	NL	Version	01	Page	3
STANDARD MANUAL					

5.2 机械特性 Mechanical Performance

序号 No.	项目 Item	测试方法 Test method	特性 Performance
5.2.2	振动试验 Resistance to vibration	在3个互相垂直的方向分别施加2小时振动，共6小时。 频率：10-55Hz 全振幅：1.5mm。 振速：1分钟内振速10~55~10Hz Direction and duration of vibration: 3 orthogonal directions mutually each for 2h , total 6h. Vibration frequency range :10-55Hz. Peak to peak amplitude: 1.5mm Sweep rate :10 to 55 to 10Hz in about 1 min.	测量电容器应无接触不良开路或短路，无可见机械损伤。 When the capacitor is measured there shall be no intermittent contacts, or open or short circuiting. There shall be no visible mechanical damage.

5.3 耐久性测试 Endurance Performance

序号 No.	项目 Item	测试方法 Test method	特性 Performance
5.3.1	稳态湿热 Resistance to damp heat (steady state)	试验温度：40±2℃ 试验时间：1344±8h 相对湿度：90~95% 试验后，电容器在标准大气条件下1~2小时，然后测试参数。 Test temperature : 40±2℃ Test time : 1344±8h Relative humidity: 90~95% After completion of test, the capacitors shall be subjected to standard atmospheric conditions for 1 to 2 hours, after which measurements shall be made.	容量变化：在初始值±10%范围内。 损失角正切值：不大于表1规定值。 漏电流：满足5.1.4要求。 外观：无异状。 Variation of capacitance: Within ±10% of the initial value. Dissipation factor: Not more than the specified value in TABLE-1. Leakage current: To satisfy No. 5.1.4 . Appearance: No remarkable abnormality.
5.3.2	高温负荷试验 Load life test	1. 试验温度：85±2℃,施加额定电压和额定纹波电流 Application of the rated voltage and the rated ripple current, test temperature:85±2℃ 2. 试验时间：参照TABLE-1寿命要求。 Testing time: refer to TABLE-1 endurance life requirements.	容量变化：在初始值±20%范围内 损耗角正切值：不超过表1规定值的200% 漏电流：满足5.1.4要求。 外观：无异状 Capacitance change: Within ±20% of the initial value. Dissipation factor: Not more than 200% of the specified value in TABLE-1. Leakage current: To satisfy No. 5.1.4 . Appearance: No remarkable abnormality.

File Description	Approval Sheet				
Component P/N	NL	Version	01	Page	4
STANDARD MANUAL					

5.3.3	高温贮存试验 Shelf life test	<p>85°C $\begin{smallmatrix} +3 \\ -0 \end{smallmatrix}$ 环境下无负荷贮存1000 $\begin{smallmatrix} +48 \\ -0 \end{smallmatrix}$ h, 至少恢复16小时后。</p> <p>The capacitors are stored with no voltage applied at 85°C $\begin{smallmatrix} +3 \\ -0 \end{smallmatrix}$ for 1000 $\begin{smallmatrix} +48 \\ -0 \end{smallmatrix}$ h and then resumed 16 hours.</p>	<p>容量变化: 初始值±20%范围内。 损耗角正切值: 不超过规定值的150%。 漏电流: 不超过规定值的200%。 外观: 无异状。</p> <p>Variation of capacitance: Within ±20% of the value before test. Dissipation factor: Not more than 150% of the specified value Leakage current: Not more than 200% of the specified value Appearance: No remarkable abnormality.</p>
5.3.4	防爆试验 Safety vent	<p>以下试验只适用于铝壳直径≥Φ22产品。 The following tests only apply to those products with vent products at diameter≥Φ22 with vent. 在电容器两极施加反向直流电压, 其中通过的电流为10A, 在测试时防爆装置应能在30分钟内动作。 DC Application test: The capacitor shall be subjected to a reverse DC voltage. The current flowing through the capacitor shall be 10A. If the vent does work with the voltage applied for 30 minutes, the test is considered to be passed.</p>	<p>上述过程中应无铝箔等散射, 无火花产生。 The safety vent is actuated under the test conditions, thereby preventing terminals, metal pieces, etc, of the capacitor from scattering due to burst, the case from separating from the seal packing, or the capacitor from producing flame.</p>

※ TABLE-2:

容量变化 Capacitance change	额定工作电压 Rated voltage	160V~500V
	C -25°C/ C 20°C	≥0.7

容量变化 Capacitance change	额定工作电压 Rated voltage	6.3V~100V
	C -40°C/ C 20°C	≥0.6

※ TABLE-3: 纹波电流频率因子 RIPPLE CURRENT FREQUENCY COEFFICIENT

WV(Vdc) \ Freq.(Hz)	50	120	300	1k	3K
10~50(V)	0.95	1.00	1.04	1.10	1.15
63~100(V)	0.95	1.00	1.06	1.16	1.25
160~500(V)	0.80	1.00	1.10	1.30	1.40

File Description	Approval Sheet				
Component P/N	NL	Version	01	Page	5
STANDARD MANUAL					

6 标记 MARKING

6.1 在电容器本体上应注明如下内容:

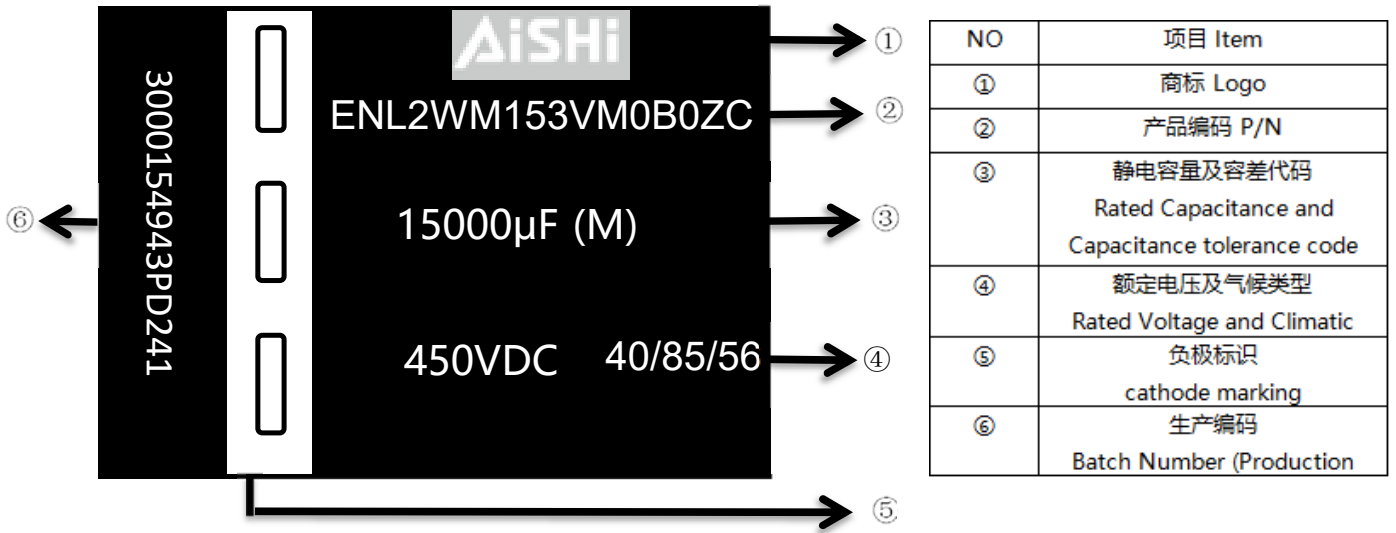

编码规则 Code rule:

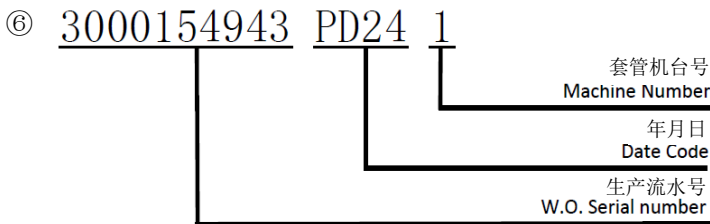

年月代号

年	2010	2011	2012	2013	2014	2015	2016	2017	2018	2019
代码	A	B	C	D	E	F	G	H	J	K
年	2020	2021	2022	2023	2024	2025	2026	2027	2028	2029
代码	L	M	N	P	R	S	T	V	W	X
年	2030	2031	2032	2033	2034	2035	2036	2037	2038	2039
代码	Y	1	2	3	4	5	6	7	8	9

月份	1	2	3	4	5	6	7	8	9	10	11	12
代码	1	2	3	4	5	6	7	8	9	0	N	D

6.2 标记颜色 Color

套管颜色: 黑色

标记颜色: 白

Sleeve color: Black

Marking color: White

File Description	Approval Sheet				
Component P/N	NR	Version	01	Page	6
STANDARD MANUAL					

7 物料编码 PART NUMBER SYSTEM

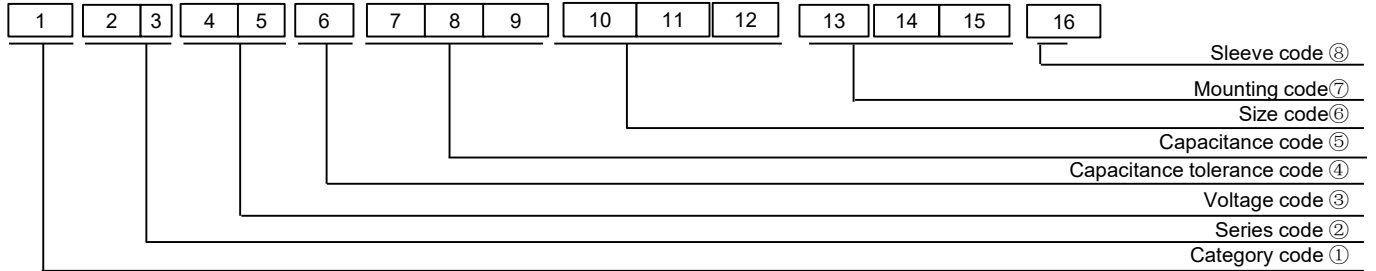

① Category code

Type	Code 1th
Electrolytic Capacitor	E

② Series code

Series name	Code	
	2th	3th
NL	N	L

③ Voltage code

WV (V)	Code	
	4th	5th
4	0	G
6.3	0	J
10	1	A
16	1	C
25	1	E
35	1	V
40	1	G
50	1	H
63	1	J
80	1	B
100	1	K
120	2	B
140	2	A
160	2	C
180	2	L
200	2	D
220	2	N
250	2	E
300	2	M
315	2	F
350	2	V
380	2	P
400	2	G
420	2	T
450	2	W
500	2	H
550	2	J

④ Capacitance tolerance code

Tol.(%)	Code	
	6th	
-10~+10	K	
-20~+20	M	
-10~+30	Q	
-5~+15	T	
-10~+20	V	
0~+20	A	
-5~+20	C	
-20~-10	B	
-5~+5	D	
0~+10	E	
-20~-5	F	
-15~+5	N	
-20~0	G	
-15~+15	H	

⑤ Capacitance code

Cap (µF)	Code		
	7th	8th	9th
330	3	3	1
470	4	7	1
560	5	6	1
680	6	8	1
820	8	2	1
1000	1	0	2
1500	1	5	2
2200	2	2	2
3300	3	3	2
4700	4	7	2
5600	5	6	2
6800	6	8	2
7400	7	4	2
8200	8	2	2
10000	1	0	3
12000	1	2	3
22000	2	2	3
33000	3	3	3
68000	6	8	3

⑥ Size code

ΦD	Code	
	10th	
35	R	
51.6	S	
64.3	T	
76.9	U	
91	V	
100	A	

L	Code	
	11th	12th
50	5	0
60	6	0
80	8	0
96	9	6
100	A	0
115	B	5
120	C	0
130	D	0
140	E	0
155	F	5
157	F	7
160	G	0
196	J	6
200	K	0
220	M	0

⑦ Terminal code

Specification	Code		Size	
	13th	14th	14th	15h
Ring clip mounting Standard design	A	*	*	*
Threaded stud Standard design	B	*	*	*
Ring clip mounting Special design	S	*	*	*
Threaded stud Special design	T	*	*	*

⑧ Sleeve code

Sleeve	Code 16th
PVC	C
PET	T

File Description	Approval Sheet				
Component P/N	NL	Version	01	Page	7
STANDARD MANUAL					

8 包装PACKING

外箱标签内容 Label on the carton

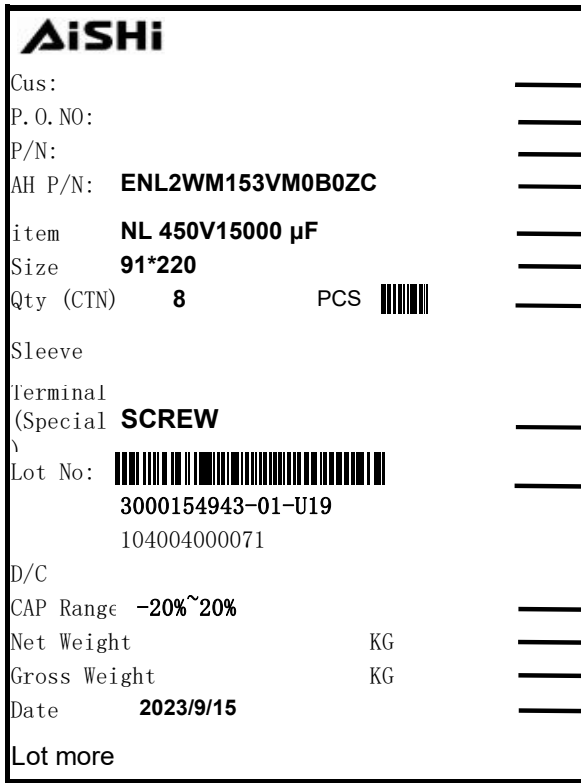

- > 客户Customer
- > 客户订单号Customer PO NO.
- > 客户料号Customer P/N.
- > AISHI料号AISHI P/N.
- > 规格Item
- > 尺寸Size
- > 包装数量Package QTY
- > 类型TERMINAL
- > 生产批号Lot NO
- > 容差范围Tolerance
- > 净重Net Weight
- > 毛重Gross Weight
- > 包装日期Date

包装按下图包装方式 Bulk Packing



外箱 carton



ΦD	数量 Quantity	外箱尺寸 (长*宽*高) Carton size (Length*Wide *Height)
35	34	400*300*120~185
51.6	20	400*300*120~185
64.3	15	400*300*120~230
76.9	12	400*300*120~260
91	8	400*300*120~285
100	6	400*300*120~285

File Description	Approval Sheet				
Component P/N	NF	Version	01	Page	8
STANDARD MANUAL					

9 其它说明 OTHER REMARKS

9.1 铝电解电容器使用注意事项

Important Information On The Application Of Aluminium Electrolytic Capacitors

(1) 直流铝电解电容器应按正确的极性使用 DC aluminium electrolytic capacitors are normally polarized

当直流铝电解电容器按反极性接入电路时，电容器会导致电子线路短路，由此产生的电流会引致电容器损坏。若电路中有可能在负引线施加正电压，请选用无极性产品。

When reverse voltage is applied to DC aluminium electrolytic capacitor, the circuit will be short out and the capacitor will be damaged due to abnormal current flows through the capacitor. Please use non-polar types of capacitors when the positive is applied on the cathode terminal.

(2) 在额定工作电压以下使用 Use capacitor within rated voltage

当电容器上所施加电压高于额定工作电压时，电容器的漏电流将上升，其电气特性将在短时间内劣化直至损坏。请注意电压峰值勿超出额定工作电压。

When capacitor is used at a higher voltage than the rated voltage, leakage current may increase and characteristics may be deteriorated and damaged in a short period of time. Please take extra caution that the peak voltage should not exceed the rated voltage.

(3) 作快速充放电使用 Rapid charge and discharge

当常规电容器被用作快速充电用途,其使用寿命可能会因为容量下降,温度急剧上升等而缩减。

When aluminium electrolytic capacitors for general purpose-use are employed in rapid charge and discharge, its life may be shortened by capacitance decrease, heat rise, etc.

(4) 电容器储存 Storage of the capacitors

① 请保管在室温5~35℃，湿度75%以下的环境。

We recommend the following conditions for storage: Ambient temperature: 5~35℃, Ambient humidity: 75%RH;

a) 通常情况下螺栓电容贮存期限为2年，如果没有超过贮存期限的电容可以直接使用，但对于电容器组的设计(并联或串联或并联、串联组合电路的电容器组)，基于安全考虑，建议在使用前对贮存6个月以上的电容器的漏电流进行测试确认满足要求再使用,不需要重新老练。

Normally, the storage time of screw capacitors is 2 years .If not exceeding the storage time, the storage capacitors can be used directly. But for capacitor bank (bank of capacitors connected in parallel or in series or in combined parallel & series circuits), for safety reason, we recommend to check the leakage current of the capacitor when it has been stored for more than 6 months before using. If the leakage current meets the requirement, the re-aging can be omitted.

b) 老练处理方法：通过串联1KΩ电阻施加额定电压1小时，通过电阻放电，放电电阻阻值1Ω/V，再在常温下放置24~48h测试漏电流。

Re-aging : the capacitors should be applied with a DC voltage which is equal to the rated voltage of the capacitor through a resistor of about 1kΩ in series for 1 hour and then discharged through a resistor of about 1Ω/V. Then, the capacitors are stored under no-voltage condition for 24 to 48 hours at room temperature, the leakage current shall then be measured.

c) 存放时间超过3年的电解电容器应报废处理； If storage time exceed three years, the products need to be discarded;

d) 库存有效期以套管上印刷的时间开始计算； Expiry date: calculating from the date marked on the sleeve;

e) 请尽量以包装状态保管； Please keep capacitors in the original package;

f) 请避免在以下环境中保管： Avoid storing the capacitors under such circumstances:

※ 溅水、高温高湿及结露的环境。 With water and oil or damp & dewing location

※ 溅油、或者充满气体油成分的环境。 With gas and oil.

※ 充满酸性有毒气体（硫化氢，亚硫酸，亚硝酸，氯，溴，溴化甲烷等）的环境。

With toxic gases such as hydrogen sulfide, sulfurous acid, nitrous acid, chlorine, bromine and methyl bromide.

※ 阳光、臭氧、紫外线及放射线照射的环境。 With direct sunlight, Ozone, ultraviolet rays or radiation.

File Description	Approval Sheet				
Component P/N	NL	Version	01	Page	9
STANDARD MANUAL					

(5) 施加纹波电流应小于额定值 Use capacitor within rated ripple current

施加纹波电流超过额定值后，会导致电容器体过热，容量下降，寿命缩短。电容器上标注了额定电压，请将和直流电压叠加的纹波电压的峰值控制在额定工作电压以下。

If excessive ripple current is applied on the capacitor, excessive heat will be generated inside, the capacitance will be reduced and capacitor's life may be shortened. Rated voltage has been marked on the capacitor; therefore, the peak value of the ripple voltage should be less than the rated voltage.

(6) 使用环境温度 Ambient temperature for application

铝电解电容器使用寿命会受到环境温度的影响。据科学统计，使用环境温度下降10°C其使用寿命增加1倍。

Life of aluminium electrolytic capacitor is affected by the ambient temperature. It is generally known that the life doubles for each 10°C decrease in temperature.

(7) 安装注意事项 Precautions for mounting

①螺钉紧固扭力矩不要超过规格书规定值。

Do not fasten the screw of the terminals and the mounting clamps over the specified torque prescribed in the catalog or the production specification.

②请勿倒立安装螺栓电容，如果需要侧卧安装，请保持正极朝上安装。

Do not mount the screw type capacitor downwards. If a screw terminal capacitor needs to be side-mounted, make sure the positive terminal is upward.

③对于M5螺钉请确保螺杆嵌入螺孔深度大于6mm, M6螺钉的螺杆嵌入螺孔深度大于7mm。

For M5 hexagon head bolt and M6 hexagon head bolt, the length of thread engagement should be greater than 6mm and 7mm respectively.

(8) 关于焊接以后的清洗 Cleaning after soldering

①电容器不能用卤化有机物系列的清洗剂进行清洗。如果必须清洗，请使用能够保证电容器质量的清洗剂。

The aluminium electrolytic capacitors should be free of halogenated solvents during board cleaning after soldering. Use solvent proof capacitors when halogenated solvents are used.

②对于能够保证电容器质量的清洗剂，清洗后请不要在清洗溶液或者密封容器中保管。清洗后的电容器请与电路板一起在热风下干燥10分钟以上，热风的温度不可高于电容器规定上限温度。

After being cleaned with the cleaning agent which can guarantee the quality of capacitors, pay attention not to keep the capacitors in cleaning solution or non-ventilated places. Dry the capacitors and PCB with hot blast for above 10 mins.

Note that the temperature of hot blast should not exceed the specified rated temperature of capacitors.

(9) 关于固定剂、镀层(涂层剂)以及PCB Concerning adhesives、coating materials(coating agent) and PCB.

①请不要使用含有卤素的固定剂、镀层(涂层剂)以及PCB。

Do not use halogen-containing adhesives, coating materials(coating agent) and PCB to fix aluminum electrolytic capacitors.

②请不要让固定剂及镀层(涂层剂)将电容器封口部位(端子一侧)全部封住。

Do not cover up all the sealing area of capacitors with adhesives or coating materials(coating agent), make coverage only partial.

9.2符合 RoHS RoHS Compliance

符合欧盟RoHS的最新标准，若客户有特殊要求，按照双方签订的相关协议为准。

Completely in accordance with the latest standard of RoHS or relevant agreements reached by both parts if customer has special requirements.

File Description	Approval Sheet				
Component P/N	NL	Version	01	Page	10
STANDARD MANUAL					