

Lithium-ion Cylindrical Battery

Model	INR18650-32M-2S1P WC2S	
Nominal voltage	7.2V	
Typical capacity	3200mAh	
Minimum capacity	3100mAh	
Standard charge	CCCV 0.2C, 8.4V±0.05V, 0.02C cut-off	
Rapid charge	CCCV 0.5C, 8.5V±0.05V, 0.02C cut-off	
Standard continuous discharge	DC, 0.2C, 4.8V cut-off	
Maximum continuous discharge	DC, 1.8C, 4.8V cut-off	
Charge/Discharge voltage range	8.5V~4.8V	
Weight	95g	
Connector type	Cvilux CP-01102010	
Protection	PCM	
Polarisation	A	
Number of cells	2	

Battery dimensions (aprox.)	
Thickness	19.5mm
Width	36.5mm
Height	66.5mm
Wires length	175mm

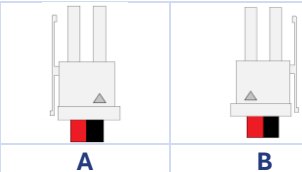
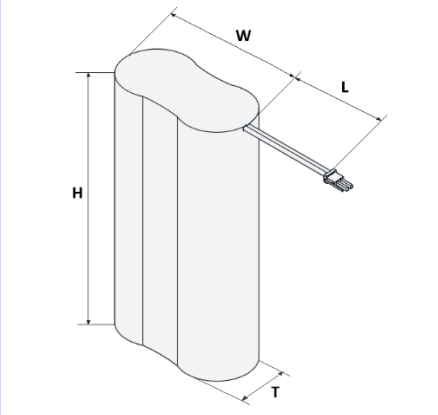

Operation temperature	Charge	0~45 °C
	Discharge	-20~60 °C
Storage temperature	1 month	-20~45 °C
	6 months	-20~35 °C
Cycle life	300 th	≥80%
Cycle life test conditions	Charge	CCCV 0.5C, 8.4V±0.05V, 0.01C cut-off
	Discharge	DC, 0.5C, 5.0V cut-off, rest time: 10min after charging and 10min after discharge
Relative capacity	Discharge temperature	25 °C
Rated capacity test conditions	Charge	0.2C, 8.4V, CCCV 0.02C cut-off
	Discharge	0.2C, 4.8V, DC cut-off voltage
	Temperature	25±2 °C
	Humidity	45~85%
Drop test	Performed with with the IEC62133 standard	
Vibration test	Performed with the UN38.3 standard	

Notes

There shall be no defects such as rust, discoloration, leakage which may adversely affect commercial value of the cell. The cell should be shipped with a voltage between 7.00V and 8.10V.

Caution

The battery may present a risk of fire or chemical burns if mistreated.
Do not disassemble or modify the cell.
Do not expose the cell to flame or extreme heat.
Do not short circuit, over-charge or over-discharge the cell.
Do not subject the cell to strong mechanical shocks or physical damage.
Do not immerse the cell in water or expose it to moisture.
Do not reverse the polarity of the cell for any reason.
Do not store or handle the cell with metallic objects.
Do not solder directly onto the cell
In event of leakage, do not make contact with electrolyte.
In event of electrolyte contact, wash yourself and seek medical attention immediately.
Do not use Lithium-ion cells in combination with other battery types.
Do not use or store the cell under direct sunlight.
Keep away from children and pets.
Replace battery with those of Akyga Battery brand only.
Do not dispose of the cell in regular household waste. Use designated recycling or hazardous waste facilities.

Ropla Elektronik HP sp. z o o.
ul. Wrocławska 1C,52-200 Suchy Dwór, Polska
Contact: sales@akygabattery.com



Akyga Battery reserves the right to make changes without notice to any product specification herein, to make corrections, modifications, enhancements or other changes. Akyga Battery or anyone on its behalf assumes no responsibility or liability for any errors or inaccuracies. Data sheet specifications and its information contained are intended to provide a product description only. "Typical" parameters which may be included on Akyga Battery data sheets and/ or specifications can and do vary in different applications and actual performance may vary over time. Akyga Battery does not assume any liability arising out of the application or use of any product or circuit. Akyga Battery products are not designed, intended or authorized for use in medical, life-saving implant or other applications intended for life-sustaining or other related applications where a failure or malfunction of component or circuitry may directly or indirectly cause injury or threaten a life without expressed written approval of Akyga Battery. Customers using or selling Akyga Battery components for use in such applications do so at their own risk and shall agree to fully indemnify Akyga Battery and its subsidiaries harmless against all claims, damages and expenditures.