

SOT-23 Plastic-Encapsulate Transistors
FEATURES

- Ideally suited for automatic insertion
- For switching and AF amplifier applications

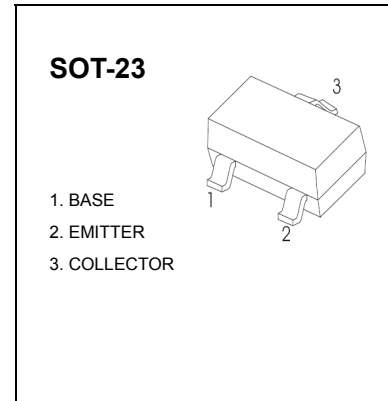

MAXIMUM RATINGS (T_a=25°C unless otherwise noted)

Symbol	Parameter	Value	Unit
V _{CB0}	Collector-Base Voltage	BC846	80
		BC847	50
		BC848	30
V _{CEO}	Collector-Emitter Voltage	BC846	65
		BC847	45
		BC848	30
V _{EBO}	Emitter-Base Voltage	6	V
I _C	Collector Current –Continuous	0.1	A
P _C	Collector Power Dissipation	200	mW
R _{θJA}	Thermal Resistance From Junction To Ambient	625	°C/W
T _J	Junction Temperature	150	°C
T _{stg}	Storage Temperature	-55~+150	°C

DEVICE MARKING

BC846A=1A; BC846B=1B;
BC847A=1E; BC847B=1F; BC847C=1G;
BC848A=1J; BC848B=1K; BC848C=1L

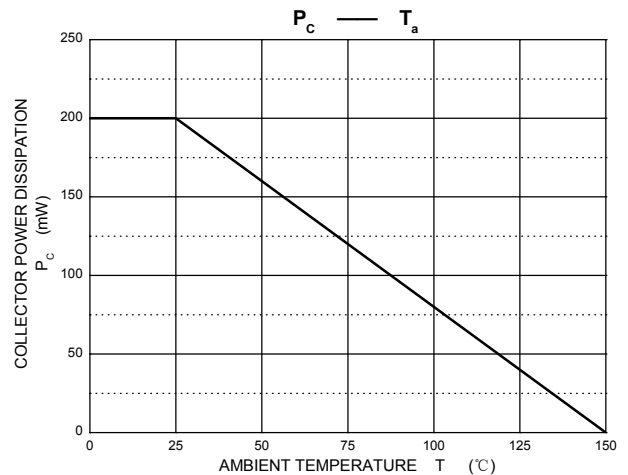
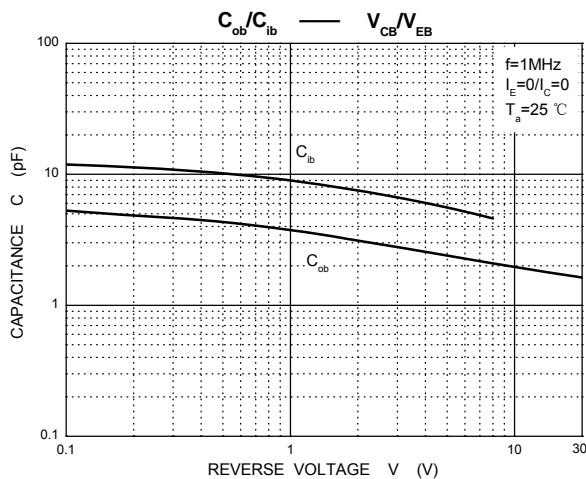
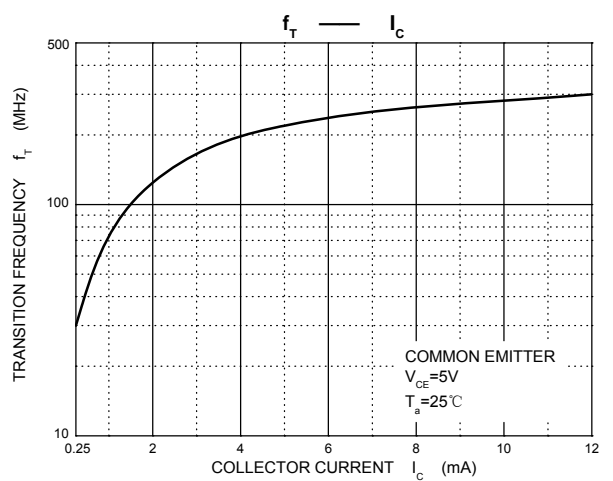
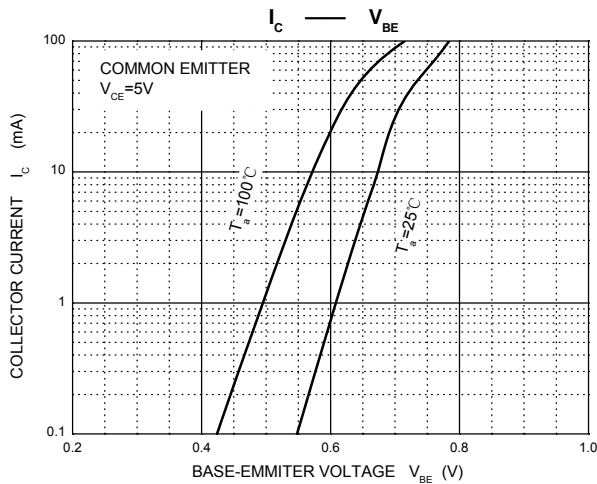
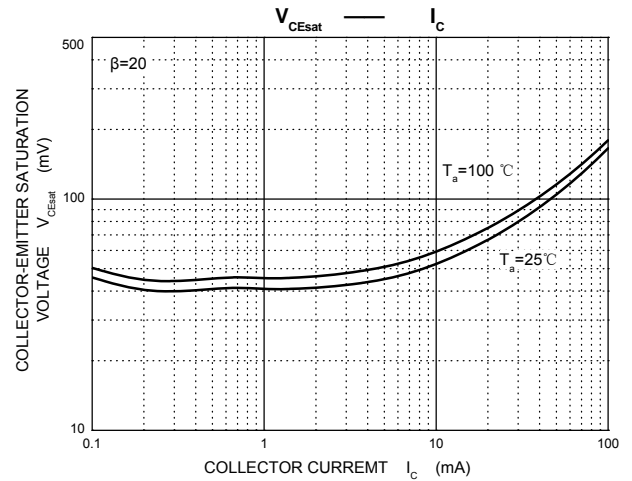
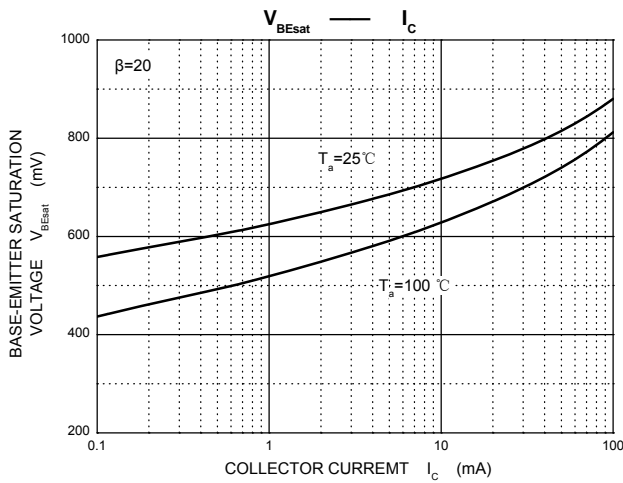
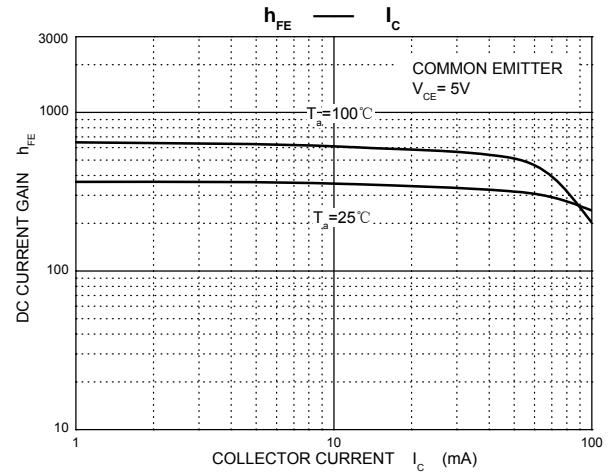
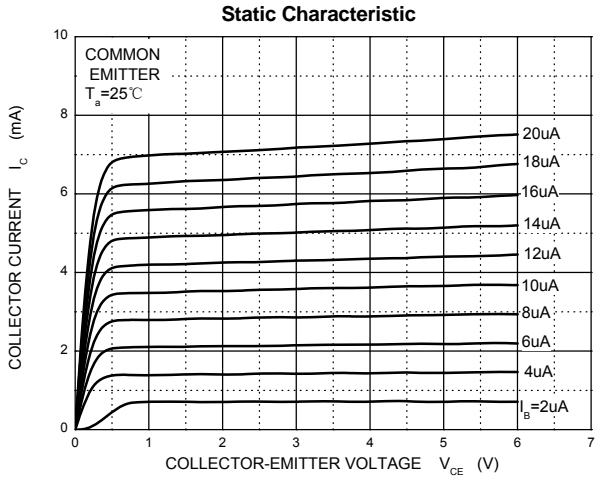
Parameter	Symbol	Test conditions	Min	Typ	Max	Unit	
Collector-base breakdown voltage	BC846	I _C = 10μA, I _E =0	80			V	
	BC847		50				
	BC848		30				
Collector-emitter breakdown voltage	BC846	I _C = 10mA, I _B =0	65			V	
	BC847		45				
	BC848		30				
Emitter-base breakdown voltage	V _{EBO}	I _E = 10μA, I _C =0	6			V	
Collector cut-off current	BC846	I _{CBO}	V _{CB} =70 V, I _E =0		0.1	μA	
	BC847		V _{CB} =50 V, I _E =0				
	BC848		V _{CB} =30 V, I _E =0				
Emitter cut-off current	I _{EBO}	V _{EB} =5 V, I _C =0			0.1	μA	
DC current gain	BC846A,847A,848A	h _{FE}	V _{CE} = 5V, I _C = 2mA	110		220	
	BC846B,847B,848B			200		450	
	BC847C,BC848C			420		800	
Collector-emitter saturation voltage	V _{CE(sat)}	I _C =100mA, I _B = 5mA			0.5	V	
Base-emitter saturation voltage	V _{BE(sat)}	I _C =100mA, I _B = 5mA			1.1	V	
Transition frequency	f _T	V _{CE} = 5 V, I _C = 10mA f=100MHz	100			MHz	
Collector output capacitance	C _{ob}	V _{CB} =10V,f=1MHz			4.5	pF	



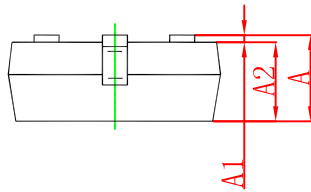
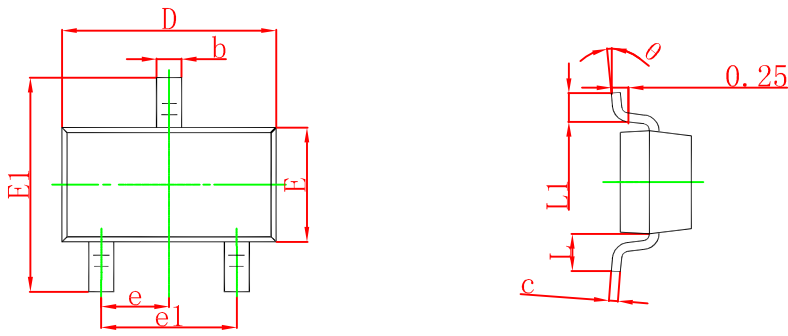

Symbol	Dimensions In Millimeters		Dimensions In Inches	
	Min	Max	Min	Max
A	0.900	1.150	0.035	0.045
A1	0.000	0.100	0.000	0.004
A2	0.900	1.050	0.035	0.041
b	0.300	0.500	0.012	0.020
c	0.080	0.150	0.003	0.006
D	2.800	3.000	0.110	0.118
E	1.200	1.400	0.047	0.055
E1	2.250	2.550	0.089	0.100
e	0.950 TYP		0.037 TYP	
e1	1.800	2.000	0.071	0.079
L	0.550 REF		0.022 REF	
L1	0.300	0.500	0.012	0.020
θ	0°	8°	0°	8°

SOT-23 Suggested Pad Layout

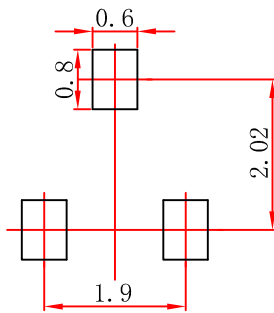

- Note:
1. Controlling dimension: in millimeters.
 2. General tolerance: $\pm 0.05\text{mm}$.
 3. The pad layout is for reference purposes only.