

---

# Fiber Optic Transmitters and Receivers for Fieldbus Applications

## Technical Data

**HFBR-1505A/2505A**  
**(SMA Tx/Rx for SERCOS)**  
**HFBR-1515B/2515B**  
**(ST® Tx/Rx for PROFIBUS)**  
**HFBR-1505C/2505A**  
**(SMA Tx/Rx for INTERBUS-S)**

---

### Features

- Meets 2/4 MBd Industrial SERCOS, 1.5 MBd PROFIBUS and INTERBUS-S Standard
- SMA and ST® Ports
- 650 nm Wavelength Technology
- Specified for Use with 1 mm Plastic Optical Fiber and 200 µm Hard Clad Silica
- Auto-Insertable and Wave Solderable
- DC – 10 MBd

### Applications

- Industrial Control Data Links
- Factory Automation Data Links
- Voltage Isolation Applications
- PLCs
- Motor Drives
- Automotive
- Sensor, Meter and Actuator Interfaces

### Description

#### SERCOS

SERCOS, an acronym for **SERIAL Realtime COmmunications System**, is a standard digital interface for communication in industrial CNC applications. The standard defines two data rates: 2 MBd and 4 MBd and was formed to allow data transfer between numerical controls and drives via fiber-optic rings, with voltage isolation and noise immunity. The HFBR-1505A/2505A products comply with SERCOS specifications for optical characteristics and connector style, and can also be used for data rates up to 10 MBd. The international standard is IEC 1491.

#### PROFIBUS

PROFIBUS, an acronym of **PROcess FIeld BUS**, is an open fieldbus standard defined for data rates ranging from 9.6 kBd to 12 MBd in selectable steps for wire and optical fiber. PROFIBUS is a German national DIN 19245 standard and a European CENELEC standard EN 50170. The ST® connector is the standard optical port of the PROFIBUS optical fiber version. The HFBR-1515B/2515B complies fully to the technical guideline using Plastic Optical Fiber up to 1.5 MBd, and can also



be used for data rates up to 10 MBd. Please contact Agilent regarding any future plans for a 12 MBd device.

#### INTERBUS-S

INTERBUS-S, a special open Sensor/Actuator Bus, is finding a broad acceptance in the factory automation industry. The HFBR-1505C was specially designed for this application and is recommended as a powerful transmitter for use with 1 mm POF and 200 µm HCS® fiber. The optical transmission guideline is a supplement of the German National DIN E 19258 standard draft. On the European level, prEN 50254 is the draft of the INTERBUS-S fieldbus. The HFBR-1505C transmitter can be used in conjunction with the HFBR-2505A receiver.

#### Package Information

All HFBR-X5X5X series transmitters and receivers are housed in a low-cost, dual-in-line

package that is made of high strength, heat resistant, chemically resistant and UL V-O flame retardant plastic. The transmitters are easily identified by the light grey colored connector port. The receivers are easily identified by the dark grey colored connector port. The package is designed for auto-insertion and wave soldering so it is ideal for high volume production applications.

### Handling and Design Information

When soldering, it is advisable to

leave the protective cap on the unit to keep the optics clean. Good system performance requires clean port optics and cable ferrules to avoid obstructing the optical path. Clean compressed air often is sufficient to remove particles of dirt; methanol on a cotton swab also works well.

### Recommended Chemicals for Cleaning/Degreasing X5X5X Products

*Alcohols:* methyl, isopropyl, isobutyl.

*Aliphatics:* hexane, heptane.

*Other:* soap solution, naphtha.

**Do not use** partially halogenated hydrocarbons such as 1,1,1 trichloroethane, ketones such as MEK, acetone, chloroform, ethyl acetate, methylene dichloride, phenol, methylene chloride or N-methylpyrrolidone. Also, Agilent does not recommend the use of cleaners that use halogenated hydrocarbons because of their potential environmental harm.

*CAUTION: The small junction size inherent in the design of these components increases the components' susceptibility to damage from electrostatic discharge (ESD). It is advised that normal static precautions be taken in handling and assembly of these components to prevent damage and/or degradation which may be induced by ESD.*

## Specified Link Performance

0°C to +70°C, DC to 10 MBd, unless otherwise noted.

Parameter	Symbol	Min.	Max.	Unit	Condition	Reference
Link Distance with HFBR-1505A/2505A or HFBR-1515B/2515B	1	0.1 0.1	40 200	m m	POF HCS®	Notes 1,2,3,4 Notes 1,2,3,5
Link Distance with HFBR-1505C/2505A	1	0.1 0.1	45 300	m m	POF HCS®	Notes 1,2,3,4 Notes 1,2,3,5
Pulse Width Distortion	PWD	-30	+30	ns	25% to 75% duty cycle	Note 1

### Notes:

1. With recommended Tx and Rx circuits (60 mA nominal drive current).
2. POF HFBR-Exxyyy 0.23 dB/m worst case attenuation.
3. HCS® HFBR-H/Vxxyyy 10 dB/Rm worst case attenuation.
4. Including a 3 dB optical safety margin accounting for link service lifetime.
5. Including a 2 dB optical safety margin accounting for link service lifetime.

## HFBR-15X5X Transmitters

The HFBR-15X5X transmitter incorporates a 650 nm LED in a light gray nonconductive plastic housing. The high light output power enables the use of both

plastic optical fiber (POF) and Hard Clad Silica (HCS®). This transmitter can be operated up to 10 MBd using a simple driver circuit. The HFBR-1505X is compatible with SMA connectors, while the HFBR-1515X mates with ST® connectors.

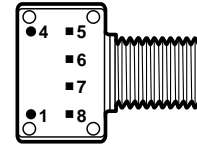

BOTTOM VIEW,  
HFBR-1505X

SEE NOTE 10

PIN	FUNCTION
1	CONNECTED TO PIN 4
4	CONNECTED TO PIN 1
5	GND
6	GND
7	CATHODE
8	ANODE

## Absolute Maximum Ratings

Parameter		Symbol	Min.	Max.	Unit	Reference
Storage and Operating Temperature		$T_{S,O}$	-40	85	°C	
Peak Forward Input Current		$I_{F,PK}$		90	mA	Note 6
Average Forward Input Current		$I_{F,AVG}$		60	mA	
Reverse Input Voltage		$V_R$		3	V	
Lead Soldering Cycle	Temp	$T_{SOL}$		260	°C	Note 7
	Time			10	s	

## Electrical/Optical Characteristics

0°C to +70°C unless otherwise noted.

Parameter	Symbol	Min.	Typ. <sup>[1]</sup>	Max.	Unit	Condition	Ref.
Optical Power Temperature Coefficient	$\Delta P_T/\Delta T$		-0.02		dB/°C		
Forward Voltage	$V_F$	1.8	2.1	2.65	V	$I_{F,dc} = 60 \text{ mA}$	Fig. 1
Forward Voltage Temperature Coefficient	$\Delta V_F/\Delta T$		-1.8		mV/°C		Fig. 1
Breakdown Voltage	$V_{BR}$	3.0	13		V	$I_{F,dc} = -10 \mu\text{A}$	
Peak Emission Wavelength	$\lambda_{PK}$	640	650	660	nm		Fig. 3
Full Width Half Max	FWHM		21	30	nm		Fig. 3
Diode Capacitance	$C_O$		60		pF	$V_F = 0 \text{ V}, f = 1 \text{ MHz}$	
Thermal Resistance	$\theta_{JC}$		140		°C/W		Notes 4,5
Rise Time (10% to 90%)	$t_r$		13		ns	10% to 90%,	
Fall Time (90% to 10%)	$t_f$		10		ns	$I_F = 60 \text{ mA}$	

**WARNING:** When viewed under some conditions, the optical port may expose the eye beyond the maximum permissible exposure recommended in ANSI Z136.2, 1993. Under most viewing conditions, there is no eye hazard.

## Peak Output Power

0°C to +70°C unless otherwise noted.

Model Number	Symbol	Min.	Max.	Unit	Condition	Reference
HFBR-1505A SERCOS	$P_T$	-10.5	-5.5	dBm	POF, $I_{F,dc} = 35$ mA	Notes 2,3,11 Figure 2
		-7.5	-3.5		POF, $I_{F,dc} = 60$ mA	
		-18.0	-8.5		HCS®, $I_{F,dc} = 60$ mA	
HFBR-1515B PROFIBUS		-10.5	-5.5		POF, $I_{F,dc} = 35$ mA	Notes 2,3,11 Figure 2
		-7.5	-3.5		POF, $I_{F,dc} = 60$ mA	
		-18.0	-8.5		HCS®, $I_{F,dc} = 60$ mA	
HFBR-1505C INTERBUS-S	-6.2	0.0	POF, $I_{F,dc} = 60$ mA	Notes 3,8,9 Figure 2		
	-16.9	-8.5	HCS®, $I_{F,dc} = 60$ mA			

### Notes:

1. Typical data at 25°C.
2. Optical power measured at the end of 0.5 meters of 1 mm diameter plastic optical fiber with a large area detector.
3. Minimum and maximum values for  $P_T$  over temperature are based on a fixed drive current. The recommended drive circuit has temperature compensation which reduces the variation in  $P_T$  over temperature, refer to Figures 4 and 6.
4. Thermal resistance is measured with the transmitter coupled to a connector assembly and fiber, and mounted on a printed circuit board.
5. To further reduce the thermal resistance, the cathode trace should be made as large as is consistent with good RF circuit design.
6. For  $I_{F,pk} > 60$  mA, the duty factor must maintain  $I_{F,avg} \leq 60$  mA and pulse width  $\leq 1$   $\mu$ s.
7. 1.6 mm below seating plane.
8. Minimum peak output power at 25°C is -5.3 dBm (POF) and -16.0 dBm (HCS®) for 1505C series only.
9. Optical power measured at the end of 1 meter of 1 mm diameter plastic or 200  $\mu$ m hard clad silica optical fiber with a large area detector.
10. Pins 1 and 4 are for mounting and retaining purposes, but are electrically connected; pins 5 and 6 are electrically isolated. It is recommended that pins 1, 4, 5, and 8 all be connected to ground to reduce coupling of electrical noise.
11. Output power with 200  $\mu$ m hard clad silica optical fiber assumes a typical -10.5 dB difference compared to 1 mm plastic optical fiber.

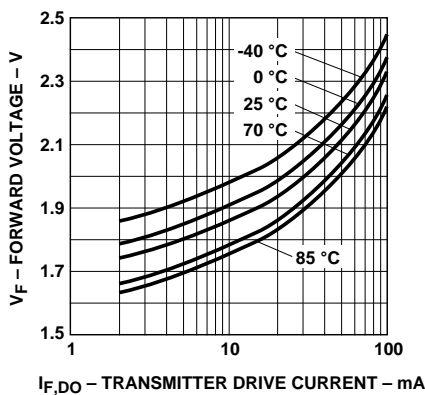

Figure 1. Typical Forward Voltage vs. Drive Current.

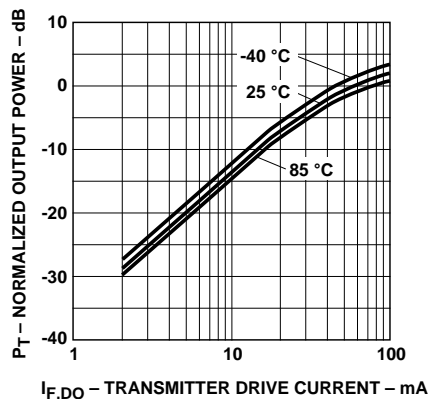

Figure 2. Typical Normalized Optical Power vs. Drive Current.

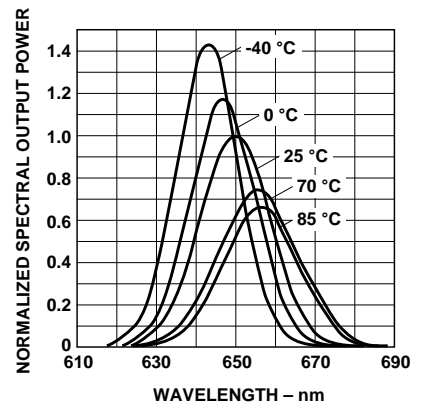

Figure 3. Typical Normalized Optical Spectra.

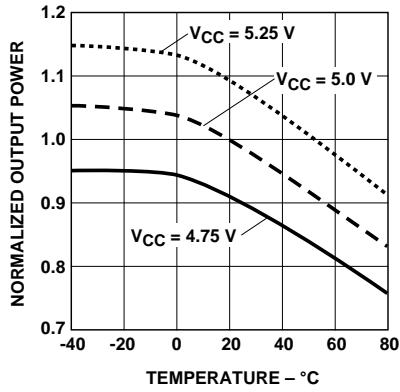

Figure 4. Typical Normalized Optical Power vs. Temperature (in Recommended Drive Circuit).

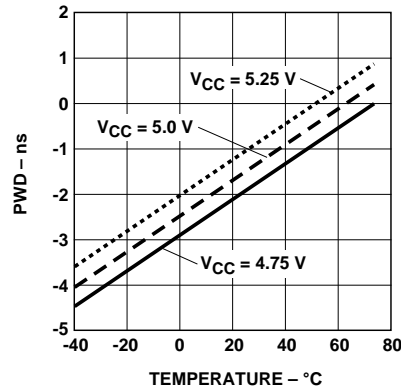

Figure 5. Typical Optical Pulse Width Distortion vs. Temperature and Power Supply Voltage (in Recommended Drive Circuit).

### Recommended Drive Circuit for HFBR-15X5X/25X5X

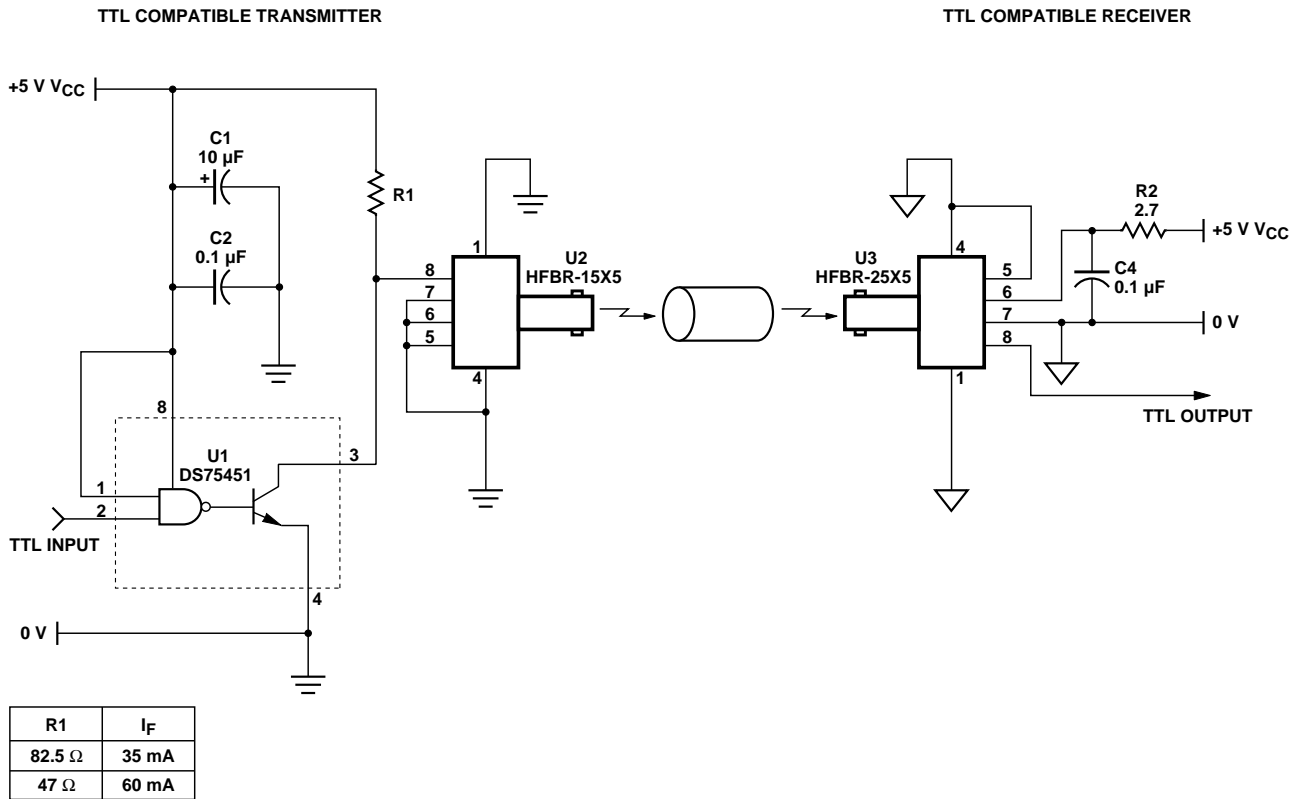
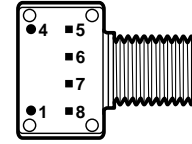

Figure 6. Recommended Transmitter and Receiver Drive Circuit (I<sub>F, on</sub> = 35 mA or 60 mA Nominal at T<sub>A</sub> = 25°C).

## HFBR-25X5 Receivers

The HFBR-25X5X receiver consists of a silicon PIN photodiode and digitizing IC to produce a logic compatible output. The IC includes a unique circuit to correct the pulse width distortion of the first bit after a long idle period. This enables operation from DC to 10 MBd

with low PWD for arbitrary data patterns. The receiver output is a “push-pull” stage compatible with TTL and CMOS logic. The receiver housing is a dark grey, conductive plastic. The HFBR-2505X is compatible with SMA connectors, while the HFBR-2515X mates with ST® connectors.



BOTTOM VIEW,  
HFBR-2505X

SEE NOTE 4

PIN	FUNCTION
1	CONNECTED TO PIN 4
4	CONNECTED TO PIN 1
5	NO CONNECT
6	V <sub>CC</sub>
7	GND
8	V <sub>O</sub>

## Absolute Maximum Ratings

Parameter	Symbol	Min.	Max.	Unit	Reference
Storage and Operating Temperature	T <sub>S</sub>	-40	85	°C	
Supply Voltage	V <sub>CC</sub>	-0.5	+5.5	V	
Average Output Current	I <sub>O,AVG</sub>	-16	-16	mA	
Output Power Dissipation	P <sub>OD</sub>		80	mW	
Lead Soldering Cycle	Temp		260	°C	Note 2
	Time		10	s	

## Electrical/Optical Characteristics

0°C to +70°C, 4.75 V < V<sub>CC</sub> < 5.25 V, V<sub>P-P</sub> Noise ≤ 100 mV, unless otherwise noted.

Parameter	Symbol	Min.	Typ. <sup>[1]</sup>	Max.	Unit	Condition	Ref.
Peak Input Power Level Logic HIGH	P <sub>RH</sub>			-42 -44	dBm	1mm POF 200 μm HCS®	Notes 3,5
Peak Input Power Level Logic LOW	P <sub>RL</sub>	-20 -22		-0 -2	dBm	1 mm POF, 200 μm HCS®  PWD  < 30 ns	Note 3 Figs. 7,8, 9,10
Supply Current	I <sub>CC</sub>		27	45	mA	V <sub>O</sub> = Open	
High Level Output Voltage	V <sub>OH</sub>	4.2	4.7		V	I <sub>O</sub> = -40 μA	
Low Level Output Voltage	V <sub>OH</sub>		0.22	0.4	V	I <sub>O</sub> = +1.6 mA	
Output Rise Time	t <sub>r</sub>		12	30	ns	C <sub>L</sub> = 10 pF	Note 3
Output Fall Time	t <sub>f</sub>		10	30	ns	C <sub>L</sub> = 10 pF	Note 3

### Notes:

- Typical data are at 25°C, V<sub>CC</sub> = 5.0 V.
- 1.6 mm below seating plane.
- In recommended receiver circuit, with an optical signal from the recommended transmitter circuit.
- Pins 1 and 4 are electrically connected to the conductive housing and are also used for mounting and retaining purposes. It is required that pin 1 and 4 be connected to ground to maintain conductive housing shield effectiveness.
- BER ≤ 10E-9, includes a 10.8 dB margin below the receiver switching threshold level (signal to noise ratio = 12).

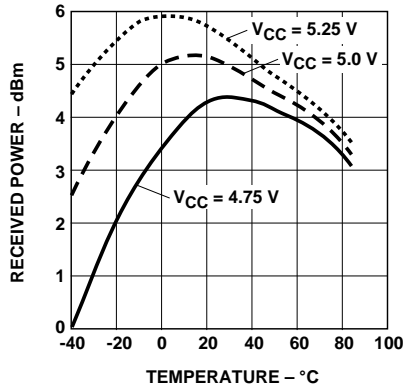

Figure 7. Typical POF Receiver Overdrive  $P_{RL,max}$  at 10 MBd vs. Temperature and Power Supply Voltage.

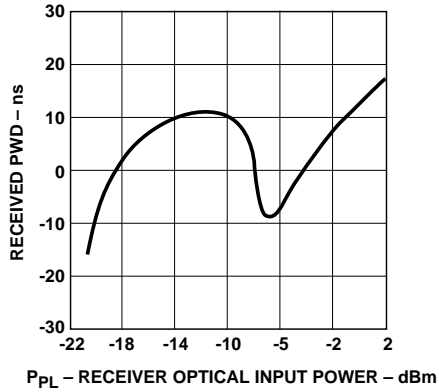

Figure 8. Typical POF Receiver Pulse Width Distortion vs. Optical Power at 10 MBd.

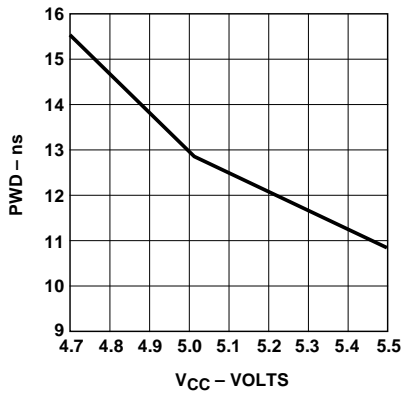

Figure 9. Typical POF Receiver Pulse Width Distortion vs. Power Supply Voltage at High Optical Power, (0 dBm, 10 MBd).

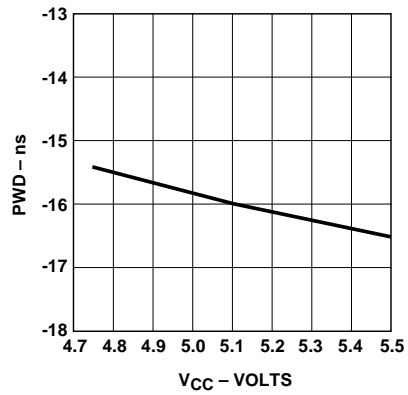
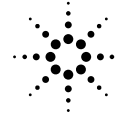
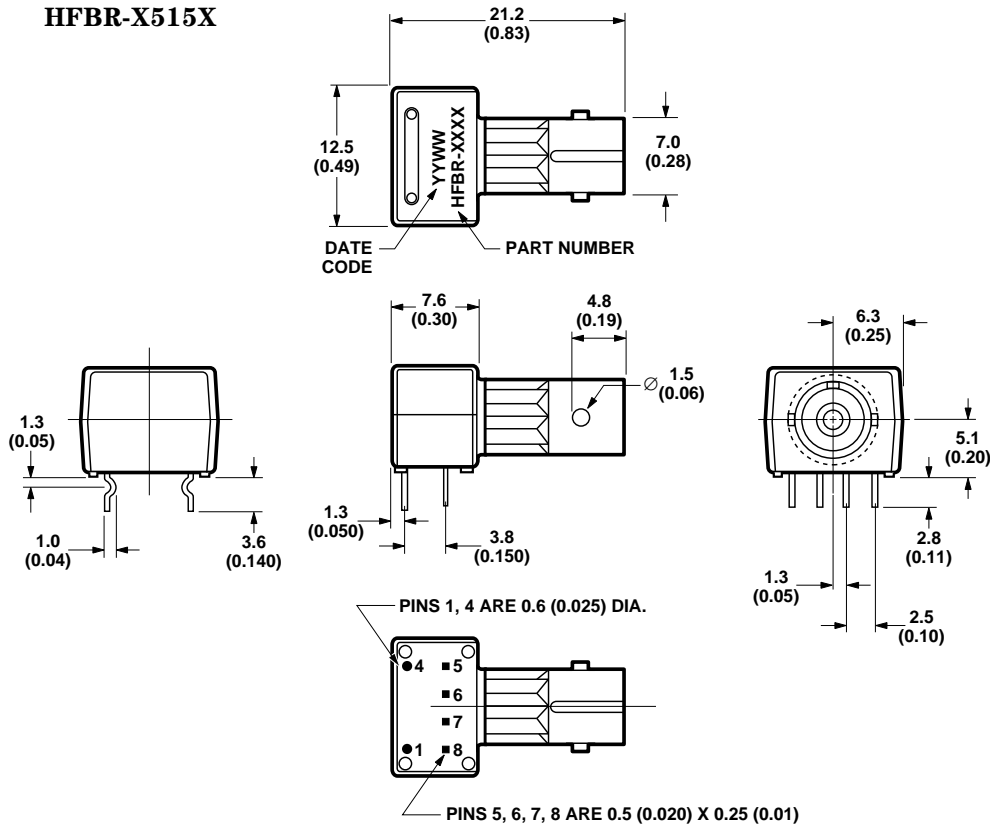

Figure 10. Typical POF Receiver Pulse Width Distortion vs. Power Supply Voltage at Low Optical Power, (-21 dBm, 10 MBd).



## Mechanical Dimensions

### HFBR-X515X



### HFBR-X505X

